

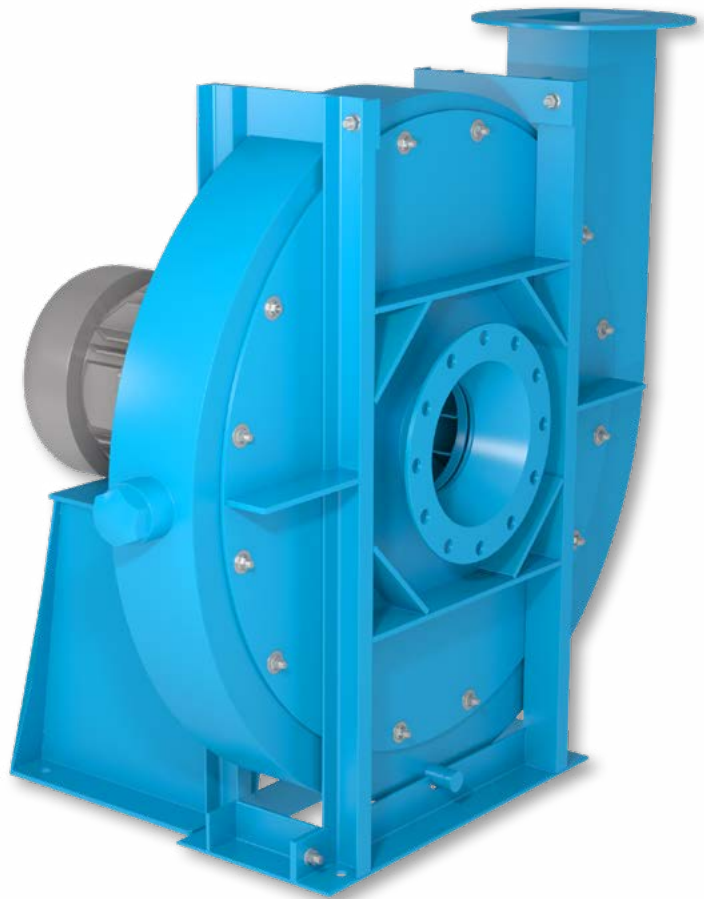

INDUSTRIAL PROCESS AND
COMMERCIAL VENTILATION SYSTEMS

HIGH PRESSURE RADIAL PRESSURE BLOWERS

HRO | HRS



Models HRO | HRS

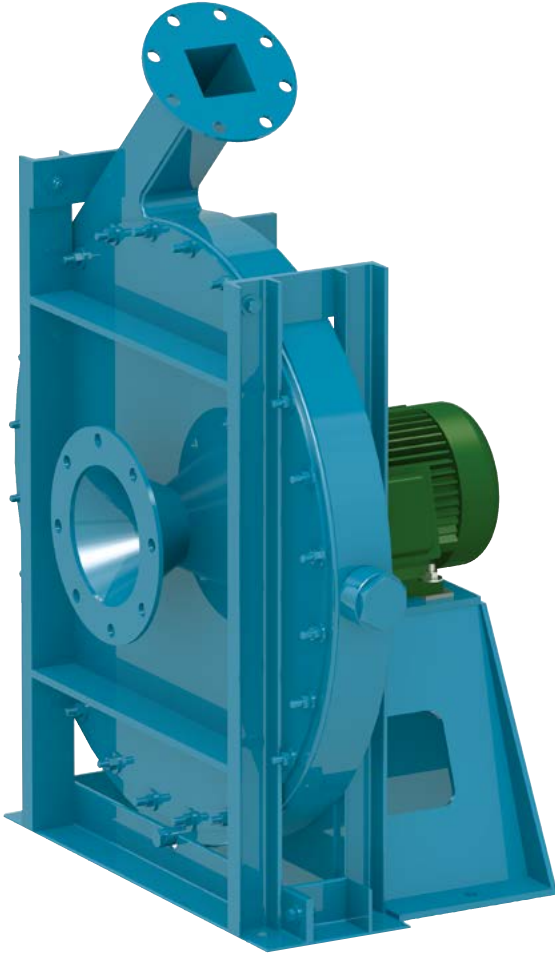

Arrangement 4

Model HRO and HRS fans from Twin City Fan & Blower are specifically designed to provide low flow and high static pressure for industrial applications. The impeller design offers maximum strength and reliability.

Available in three (3) designs, the HRO and HRS allow for flexibility in selection depending upon the application. The design allows for a low flow reducing or even eliminating the requirement for recirculating or exhausting excess air. Design 1 has the lowest flow, followed by Design 2, and then Design 3.

Typical Applications

- Air pollution control systems
- Combustion air
- Exhausting
- Gas boosting
- Glass blowing and cooling
- Liquid agitation
- Mist elimination
- Pneumatic conveying
- Pressure and vacuum drying
- Primary air supply to ejectors
- Product cooling
- Selective catalytic recovery
- Sulfur recovery
- Vapor recovery
- Water blow-off

Design Features

- Designed for continuous duty in high pressure, low flow applications
- Uniform pressures throughout the operating range

Model HRO

- Impeller: radial bladed with backplate and no front shroud
- Two (2) designs (Design 1 and 3)
- Capable of handling low particulate or vapor
- Volumes to 4.0 m³/sec
- Pressures to 25,600 Pa

Model HRS

- Impeller: radial bladed with backplate and shroud
- Three (3) designs (Design 1, 2 and 3)
- Capable of handling low particulate or vapor
- Volumes to 4.7 m³/sec
- Pressures to 29,830 Pa



Arrangement 4

Arrangement 4 is a direct drive fan with the impeller mounted directly on the motor shaft. This drive arrangement is the most compact and requires minimum maintenance and service. Standard Arrangement 4 fans are suitable to 93°C operating temperature. Maximum rotational speeds for Arrangement 4 fans can be found on page 6.

Arrangement 8

Arrangement 8 is a direct-drive unit with the impeller mounted on a separate fan shaft that is mounted to the fan pedestal with pillow block bearings (minimum L-10 40,000 hours). The fan shaft is connected to the motor shaft with a flexible coupling. Arrangement 8 blowers offer the ability to remove the motor for service without disturbing the fan assembly. Arrangement 8 units are limited to 148°C as standard. High temperature packages are available for up to 316°C. Maximum rotational speeds for Arrangement 8 fans can be found on page 6.

Arrangement 1

V-belt drive fans are available in arrangement 1 only. Arrangement 1 units are limited to 148°C as standard. High temperature packages are available for up to 316°C. Maximum rotational speeds for Arrangement 1 fans can be found on page 6.

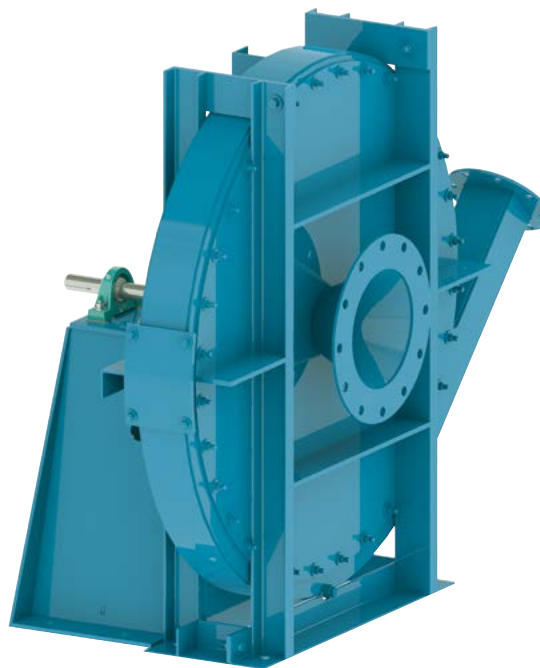

Arrangement 1

IMPELLER DESIGN

All impellers are constructed to insure maximum strength and reliability. Impellers are statically and dynamically balanced on the most modern electronic equipment. Every blower unit is given a final running mechanical test and trim balance before shipment.

HRO (Radial, Open Impeller)

The HRO impeller features a full back plate with radial blades that are constructed of steel. The HRO is ideal for light particulate- or vapor-laden gas streams. The HRO is only available in Designs 1 and 3.

HRS (Radial, Shrouded Impeller)

The HRS impeller features a full backplate and a fully shrouded frontplate. The HRS design develops the most pressure for a given speed and offers the highest efficiency. The HRS is available in Designs 1, 2, and 3.

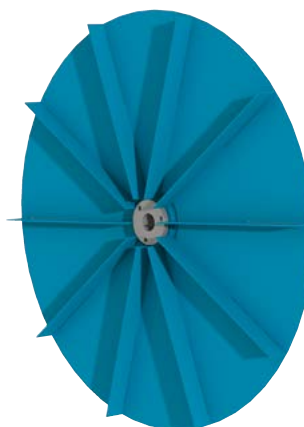

HRO Impeller

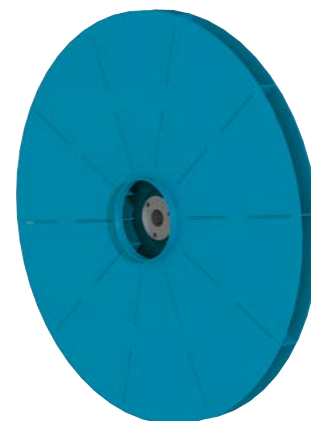

HRS Impeller

CONSTRUCTION FEATURES



Flanged Inlet



Flanged Outlet



Shaft Seal



Housing Drain with Plug

Flanged Inlet

The standard flanged inlet enables attachment of rigid pipe connections on the blower inlet. The flange is drilled to match 125/150# ANSI pipe flange.

Flanged Outlet

The standard flanged outlet enables attachment of rigid pipe connections on the blower outlet. The flange is drilled to match 125/150# ANSI pipe flange.

Shaft Seal

Standard shaft seals are mounted on the drive side of the blower housing. They consist of a ceramic felt element in compression to minimize air leakage. This shaft seal does not make the fan gas tight. Consult factory for other available shaft seal options.

Housing Drain with Plug

The standard housing drain consists of an NPT half-coupling and plug mounted at the fan housing in the lowest point allowing for drainage of condensate from fan housing. A plug is included.

ACCESSORIES



Access Port



Shaft and Bearing Guard

Outlet Blast Gate

A manually actuated blast gate for mounting to the fan outlet flange allows for controlling flow to full shutoff. Available for automatic control. Maximum temperature 121°C.

Access Port

Heavy duty access port provides access for impeller inspection. Depending on the fan size, access port may be NPT coupling and plug or a panel.

Inlet Bell

Installations with an open inlet, an inlet bell (venturi) is required to achieve the catalog performance. Inlet screen is available.

Belt Guard

An OSHA belt guard protects personnel from the moving drive parts. A quick access guard is available.

Shaft and Bearing Guard

Solid sheet metal guards cover shaft and bearings and come with extended lube lines to a common point out either side of the guard. A guard spanning the shaft between the bearings is also available to provide easy access to bearings for lubrication and vibration monitoring. Optional painted safety yellow is available.

Split Housing

All sizes are designed to permit impeller removal through the fan inlet. Sizes 40 and larger are available with a horizontal, pie-shaped, or 3-way split housing, which allows removal of the impeller and shaft without disconnecting ductwork.

Spark Resistant Construction

Fan applications may involve the handling of fumes or vapors. Such applications require careful consideration by the system designer to insure the safe handling of such gases. Twin City Fan & Blower offers the following classifications of spark resistant construction per AMCA Standard 99-0401. It is the specifier's or the user's responsibility to specify the type of spark resistant construction with full recognition of the potential hazards and the degree of protection required.

Construction

Type A: All parts of the fan in contact with the air-stream must be made of nonferrous material — usually an aluminum and limited to 93°C.

Type B: The fan shall have a nonferrous impeller and nonferrous rub ring about the opening through which the shaft passes — usually an aluminum impeller and rub ring and limited to 93°C.

Type C: Consult factory.

Nominally Leak-Tight Construction

When leakage is a concern, nominally leak-tight construction should be considered. For fans with positive pressure conditions at the inlet, please consult the factory.

Nominally leak-tight is available for arrangement 1 and arrangement 8 fans. Construction modifications may include, but are not limited to (depending on the application) continuously welded inlet and outlet flanges, close-centered bolts on all flanges, access doors, cover plates, Buna-N rubber shaft seal as standard (other mechanical seals available).

High Temperature Package Fan

Standard designs are suitable to 93°C for Arr. 4 and 149°C for Arr. 1 and Arr. 8 fans. Units in Arr. 1 and Arr. 8 fans can be modified to suit applications to 316°C. Apply to Twin City Fan for applications above 316°C.

149 to 260°C: Package includes shaft cooler with guard, high temperature grease, and TCF blue enamel paint.

261 to 316°C: Package includes the 149 to 260°C package modifications plus the addition of high-temp aluminum paint.

Special materials of construction are available. Consult factory for availability and pricing.



Bearing with Shaft Cooler & Shaft Seal

Table 1: Derating Factors for Safe Impeller Speed

Temperature (°C)	Alloy Steel	Stainless Steel
20	1.00	0.99
95	0.99	0.95
120	0.98	0.93
150	0.97	0.91
205	0.95	0.87
260	0.93	0.83
315	0.90	0.80

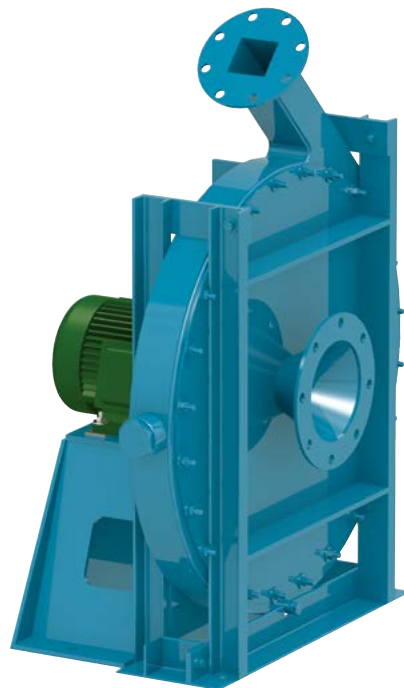

Table 2. Impeller Weights, WR²

FAN SIZE	DESIGN 1			DESIGN 2			DESIGN 3		
	DIAMETER (mm)	IMPELLER WEIGHT (kg)	WR ² kg-m ²	DIAMETER (mm)	IMPELLER WEIGHT (kg)	WR ² kg-m ²	DIAMETER (mm)	IMPELLER WEIGHT (kg)	WR ² kg-m ²
25	558.80	15.9	0.57	539.75	15.4	0.52	501.65	14.1	0.4
30	666.75	23.1	1.15	647.70	23.1	1.07	603.25	20.9	0.83
35	781.05	40.4	2.81	755.65	39.5	2.57	704.85	35.8	2.02
40	889.00	50.3	4.67	863.60	49.9	4.34	806.45	45.4	3.41
45	1003.30	81.6	9.39	971.55	78.9	8.5	908.05	71.7	6.69
50	1111.25	97.5	14.0	1079.50	94.8	12.8	1009.65	85.7	10.1
55	1225.55	151	40.3	1187.45	136	23.9	1111.25	132	18.9
60	1333.50	183	37.0	1295.40	178	33.9	1212.85	162	26.9
65	1460.50	219	52.8	1403.35	214	48.4	1308.10	194	38.1
70	1555.75	249	70.1	1511.30	244	64.8	1384.30	221	51.1

Table 3. Maximum RPM, Shaft & Bearings

FAN SIZE	ARRANGEMENT 1				ARRANGEMENT 8			
	MAX RPM	MAX kW	SHAFT DIA. (mm)	BEARING TYPE	MAX RPM	MAX kW	SHAFT DIA. (mm)	BEARING TYPE
25	3600	7.5	30	HDB-C	3600	7.5	30	SDB-C
30	3600	18.5	55	HDB-C	3600	18.5	30	SDB-C
35	2700	37	50	RB-C & RB-CE	3600	37	35	SDB-C
40	2500	75	65	RB-C & RB-CE	3600	75	45	HDB-C
45	2500	150	65	RB-C & RB-CE	3600	150	55	HDB-C
50	1800	30	50	RB-C & RB-CE	1800	30	45	HDB
55	1800	45	55	RB-C & RB-CE	1800	45	50	HDB
60	1800	75	70	RB-C & RB-CE	1800	75	65	HDB
65	1800	110	85	RB-C & RB-CE	1800	110	55	RB-C & RB-CE
70	1800	185	85	RB-C & RB-CE	1800	185	70	RB-C & RB-CE

Note: The "C" in the bearing type denotes a concentric locking-type bearing.

Table 4. Minimum and Maximum Motor Frame Sizes for Arrangement 4 fans

HOUSING SIZE	MAX RPM	MINIMUM				MAXIMUM			
		1500 RPM (4-POLE MOTOR)		3000 RPM (2-POLE MOTOR)		1500 RPM (4-POLE MOTOR)		3000 RPM (2-POLE MOTOR)	
		kW	FRAME SIZE	kW	FRAME SIZE	kW	FRAME SIZE	kW	FRAME SIZE
25	3600	0.75	80	2.2	100L	4	112M	7.5	132M
30	3600	1.1	90S	5.5	132S	7.5	132M	18.5	180M
35	3600	2.2	100L	11	160M	18.5	180M	37	225S
40	3600	5.5	132S	22	180L	37	225S	75	280S
45	3600	11	160M	37	225S	55	250S	150	315S
50	1800	15	160L	N/A	N/A	30	200L	N/A	N/A
55	1800	30	200L	N/A	N/A	45	225S	N/A	N/A
60	1800	45	225S	N/A	N/A	75	280S	N/A	N/A
65	1800	75	280S	N/A	N/A	110	280M	N/A	N/A
70	1800	90	280M	N/A	N/A	185	315S	N/A	N/A

Table 5. Bare Fan Weights, kg

FAN SIZE	ARRANGEMENT 1			ARRANGEMENT 4		
	DESIGN 1	DESIGN 2	DESIGN 3	DESIGN 1	DESIGN 2	DESIGN 3
25	108	108	106	98	98	95
30	179	178	173	162	160	155
35	183	245	246	251	248	251
40	318	315	310	352	348	342
45	400	426	424	492	518	517
50	493	489	477	476	471	440
55	664	657	638	620	611	591
60	792	780	761	748	734	713
65	936	924	894	880	853	659
70	1103	1087	1043	1143	1124	1075

Note: Arrangement 1 weights do not include the weight of drives or motors. Arrangement 4 weights do not include the weight of the motor.

The performance curves in this catalog are based on fans handling standard air at a density of 1.2 kg/m³. This is equivalent to air at 21°C at sea level (101.325 kPa barometric pressure). Thus, when specified performance is at a density other than standard, it must be converted to the equivalent standard conditions before entering the performance curves. The equivalent standard conditions can be calculated by using the Twin City Fan & Blower Fan Selector Program.

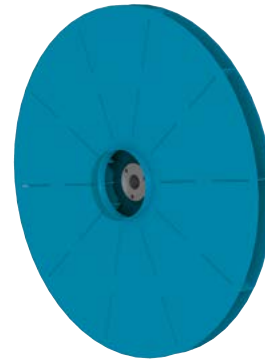
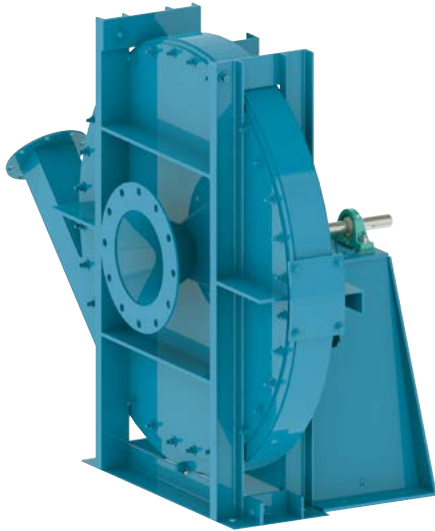

HRS Impeller

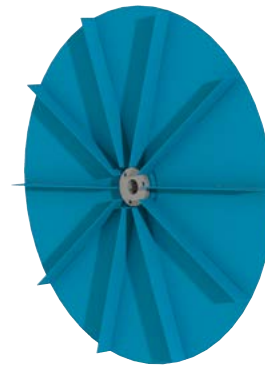

HRO Impeller

MODEL NOMENCLATURE

Model _____

- HRO = Open Front Impeller
- HRS = Shrouded Impeller

Design _____

- Design 1 (HRO & HRS)
- Design 2 (HRS Only)
- Design 3 (HRO & HRS)

Housing Size _____

- (25, 30, 35, 40, 45, 50, 55, 60, 65, 70)

HRS - 3 - 45



HRO 125

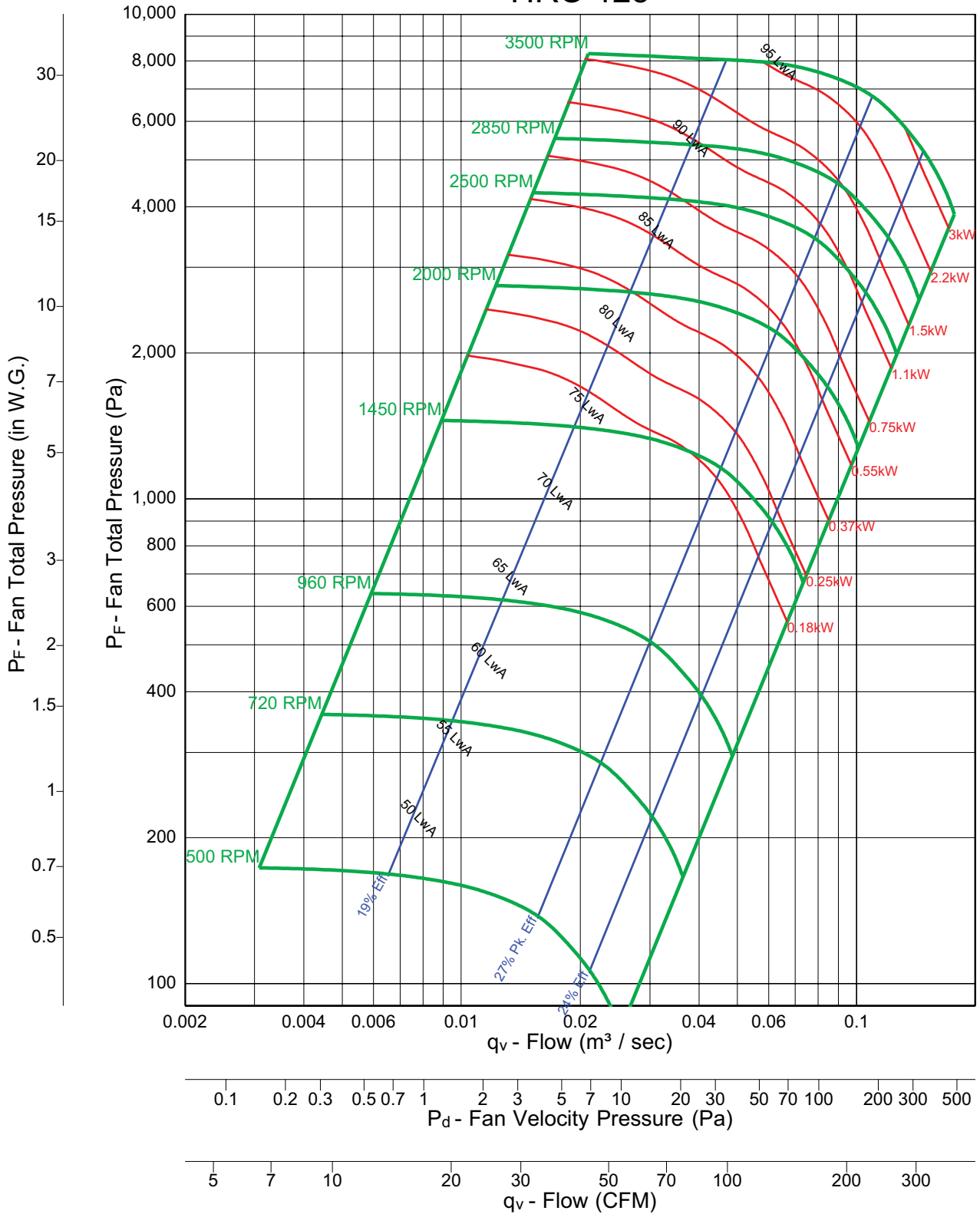

HRO 130

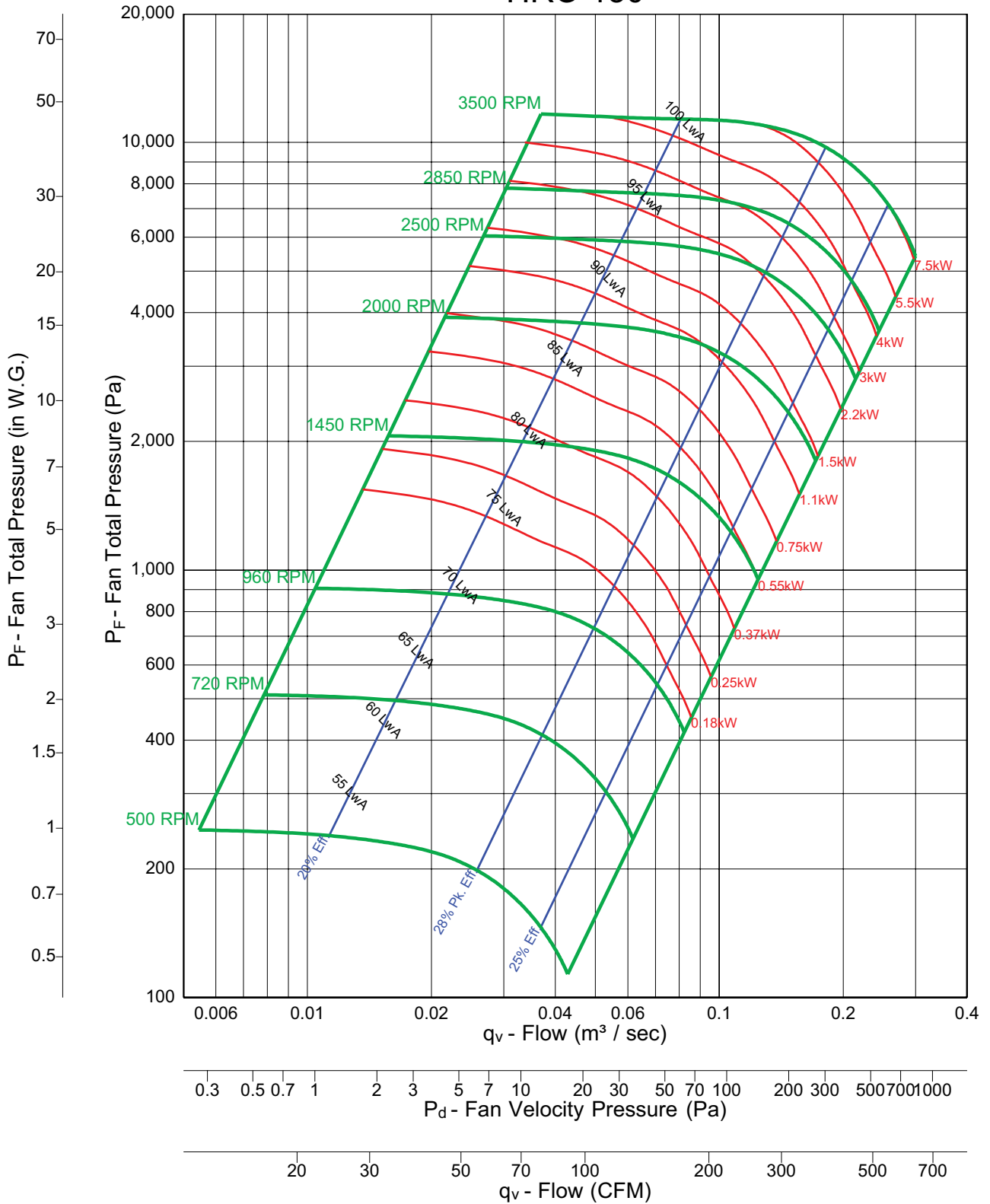

HRO 135

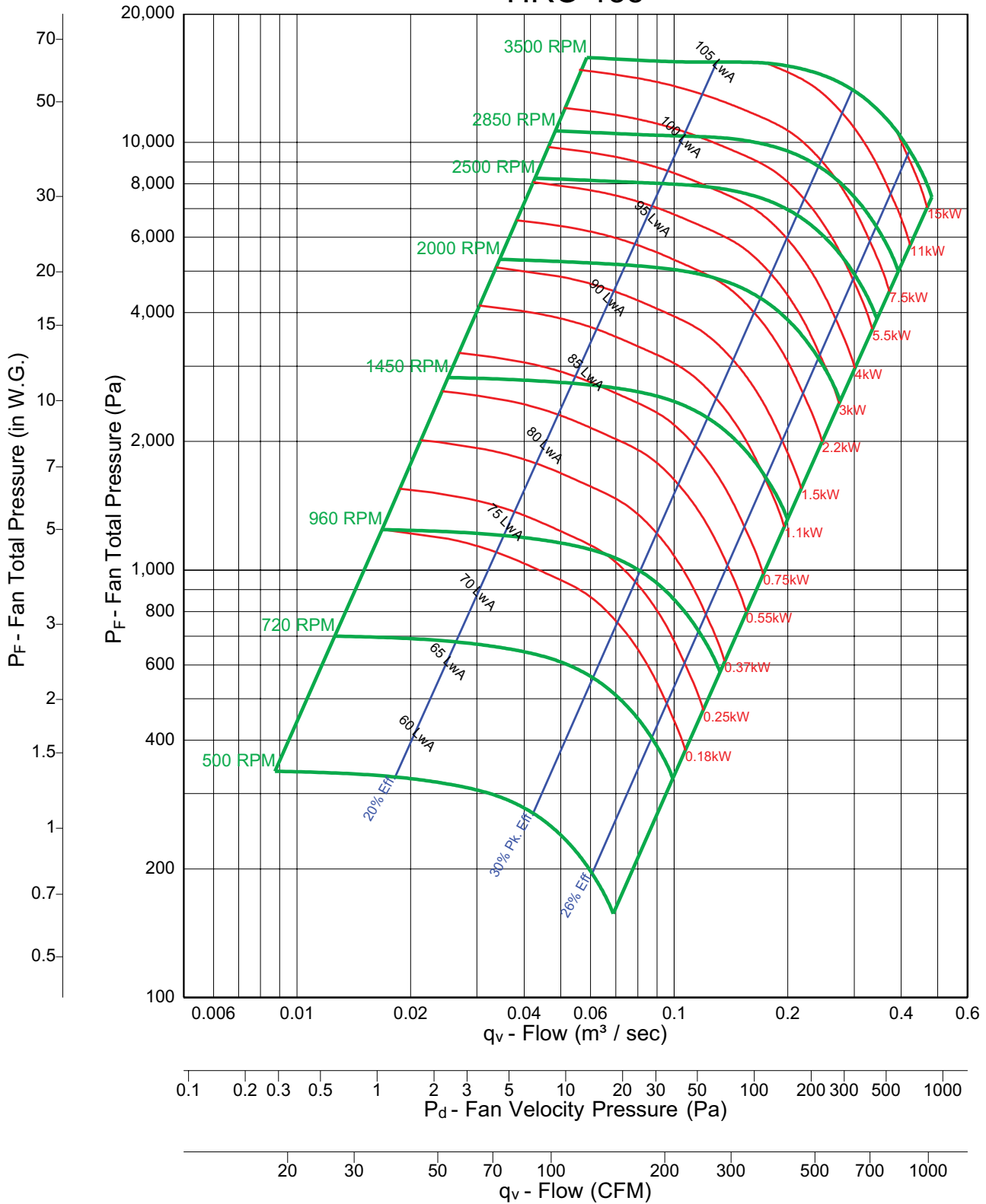

HRO 140

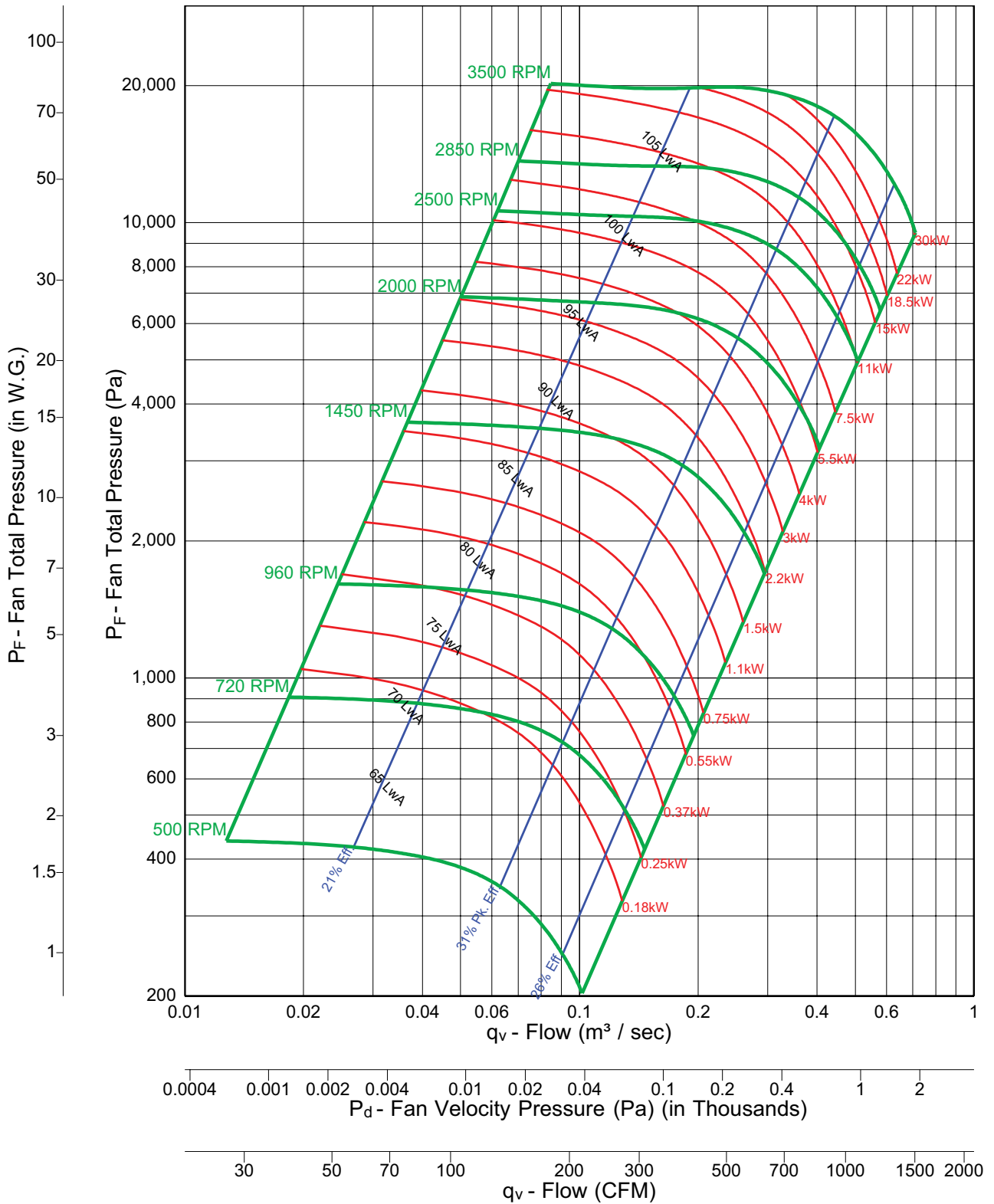

HRO 145

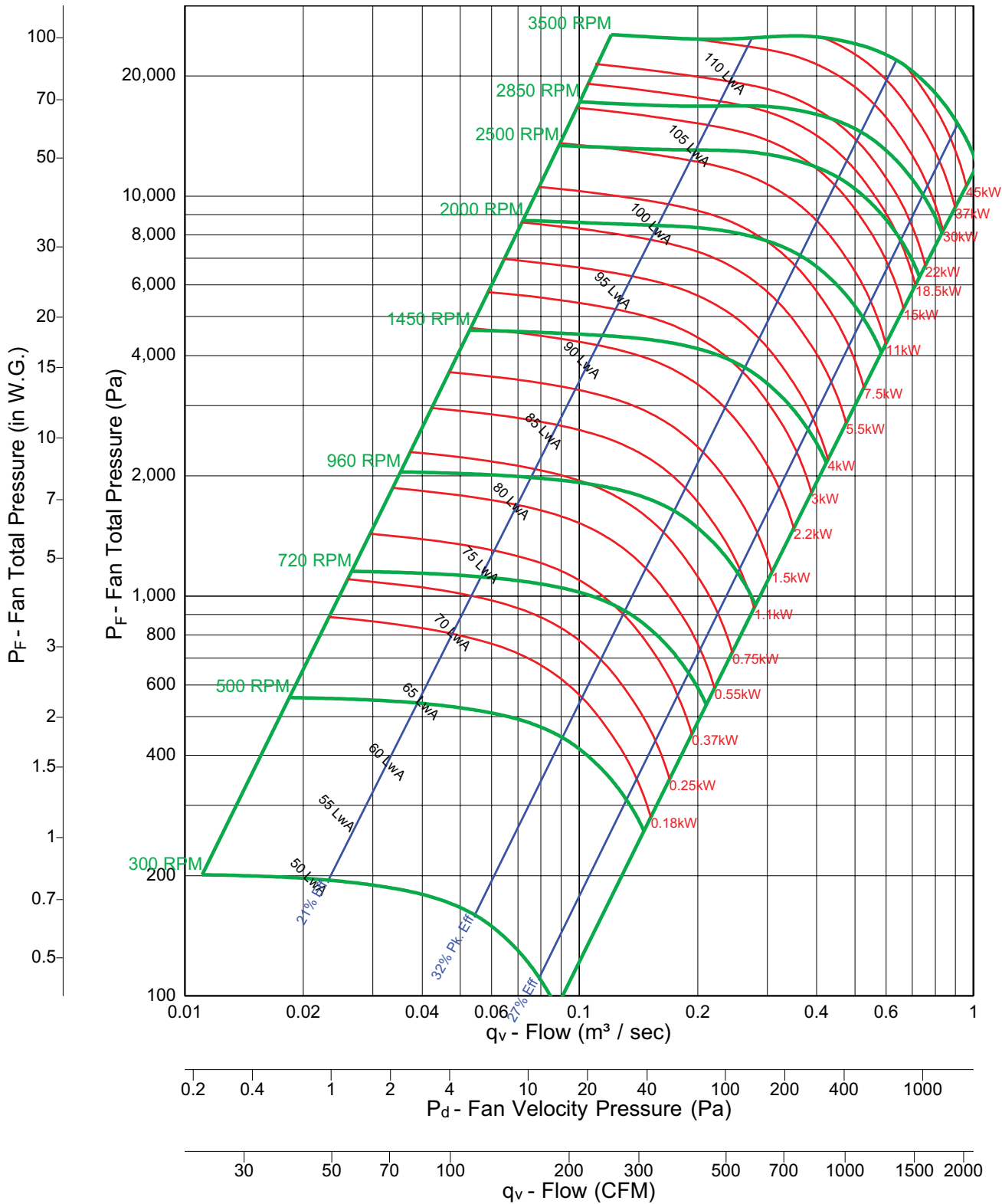

HRO 150

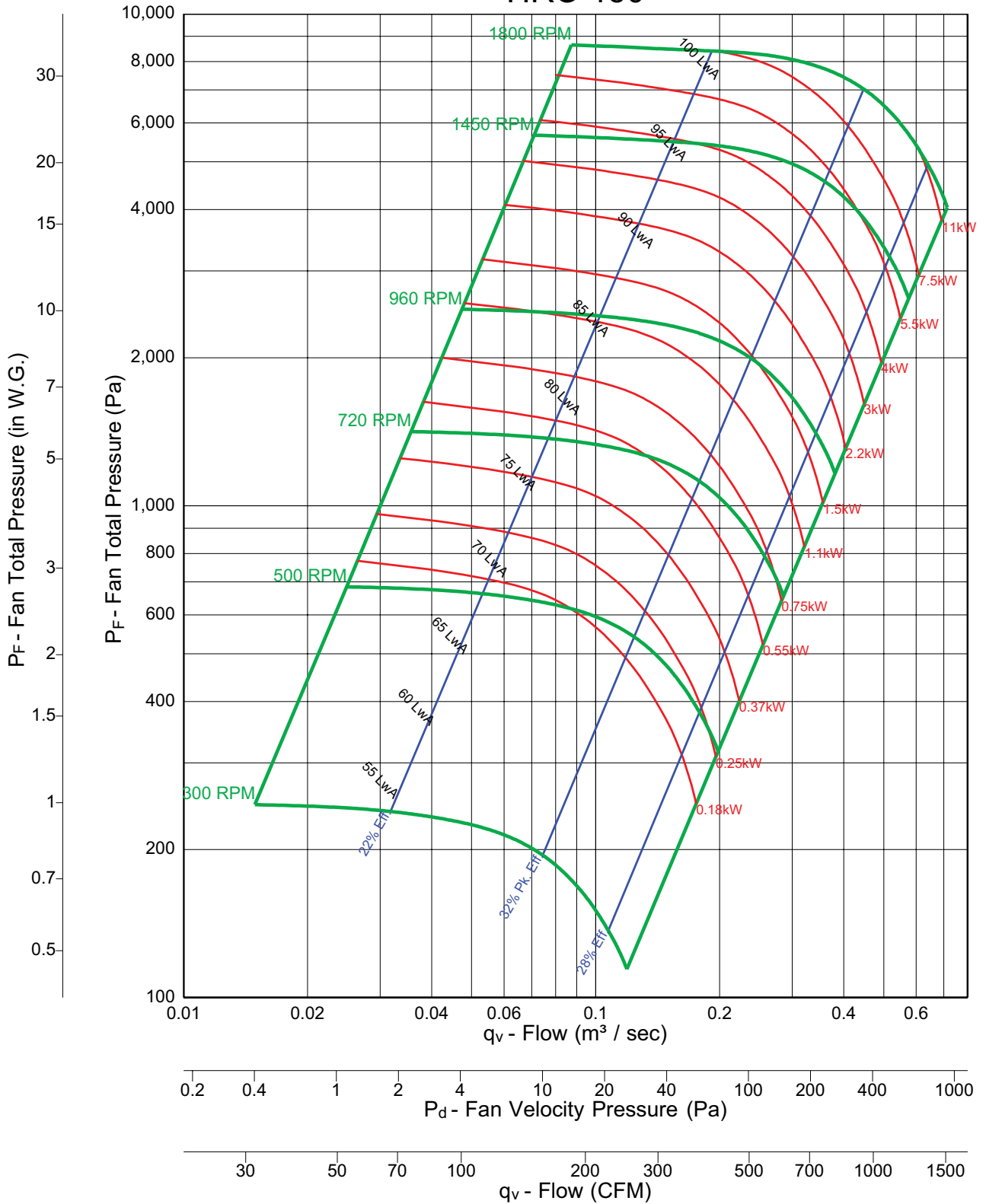

HRO 155

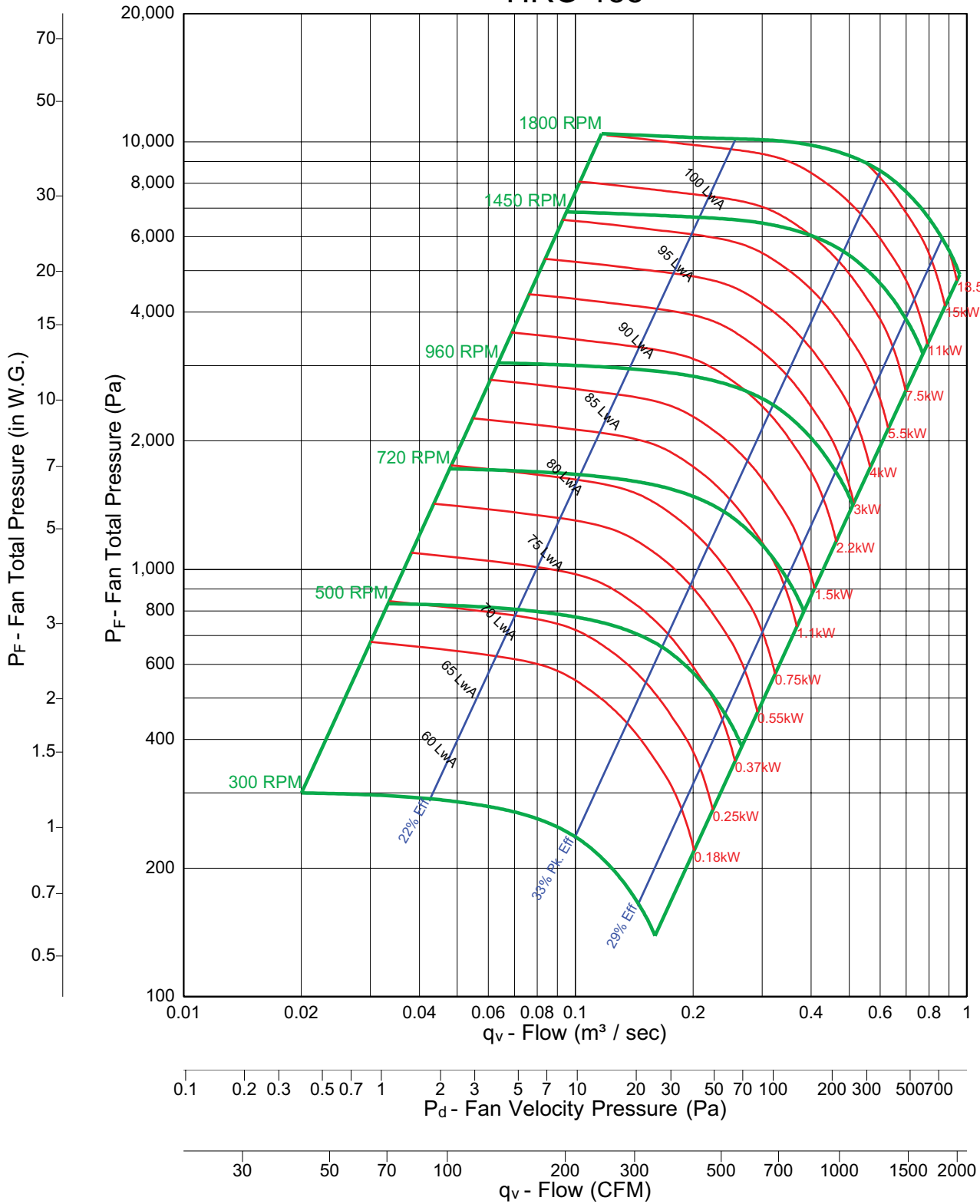

HRO 160

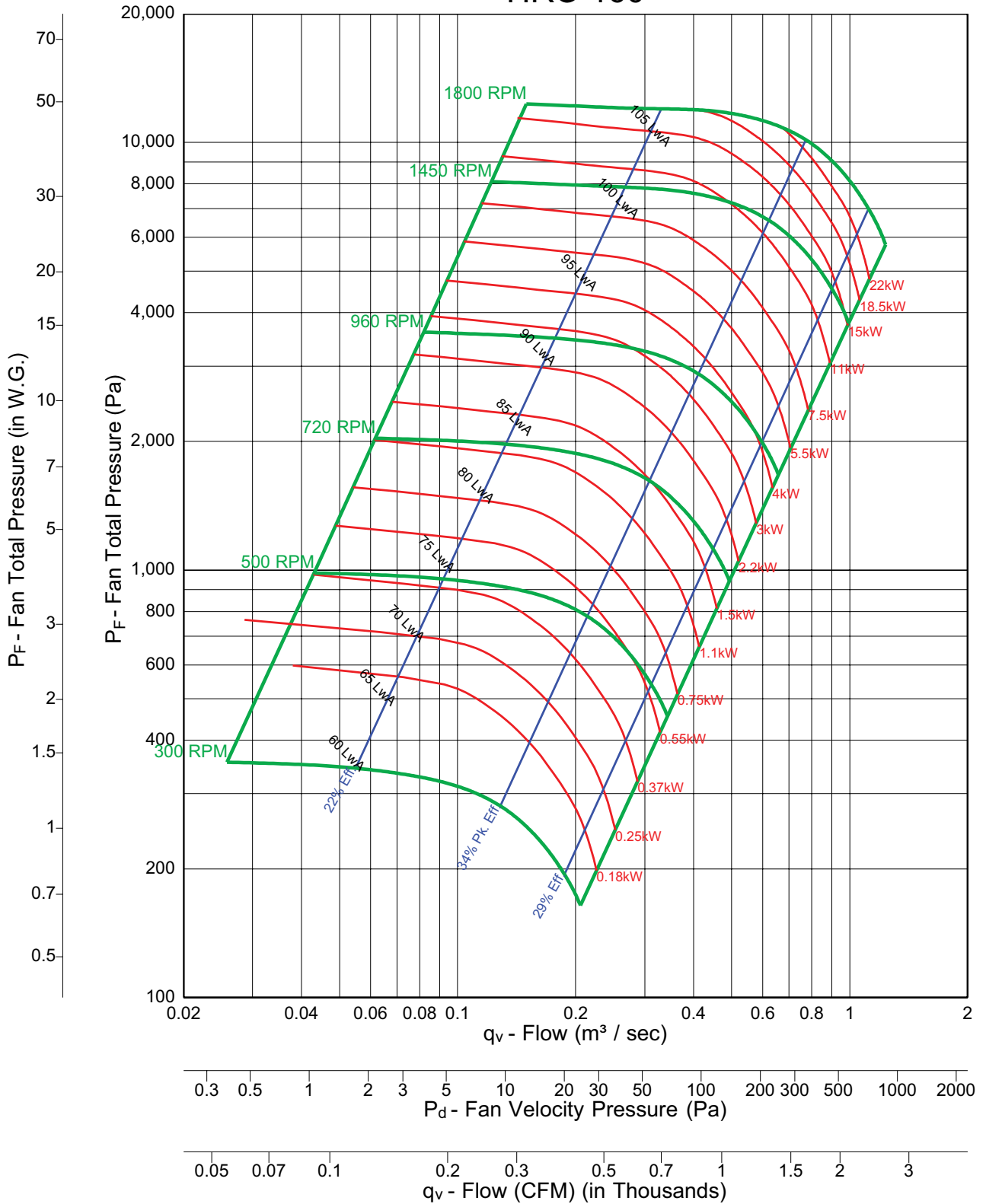

HRO 165

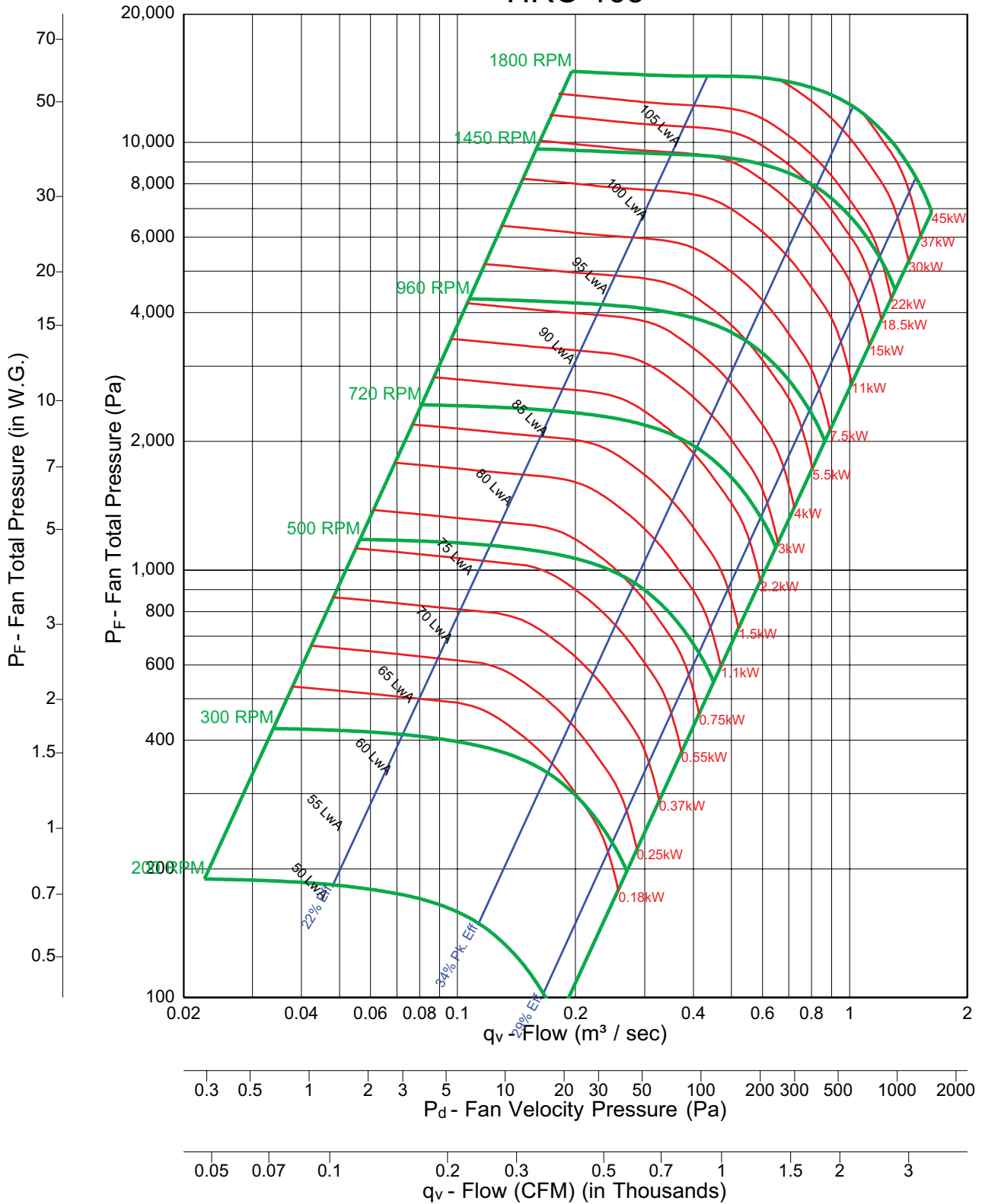

HRO 170

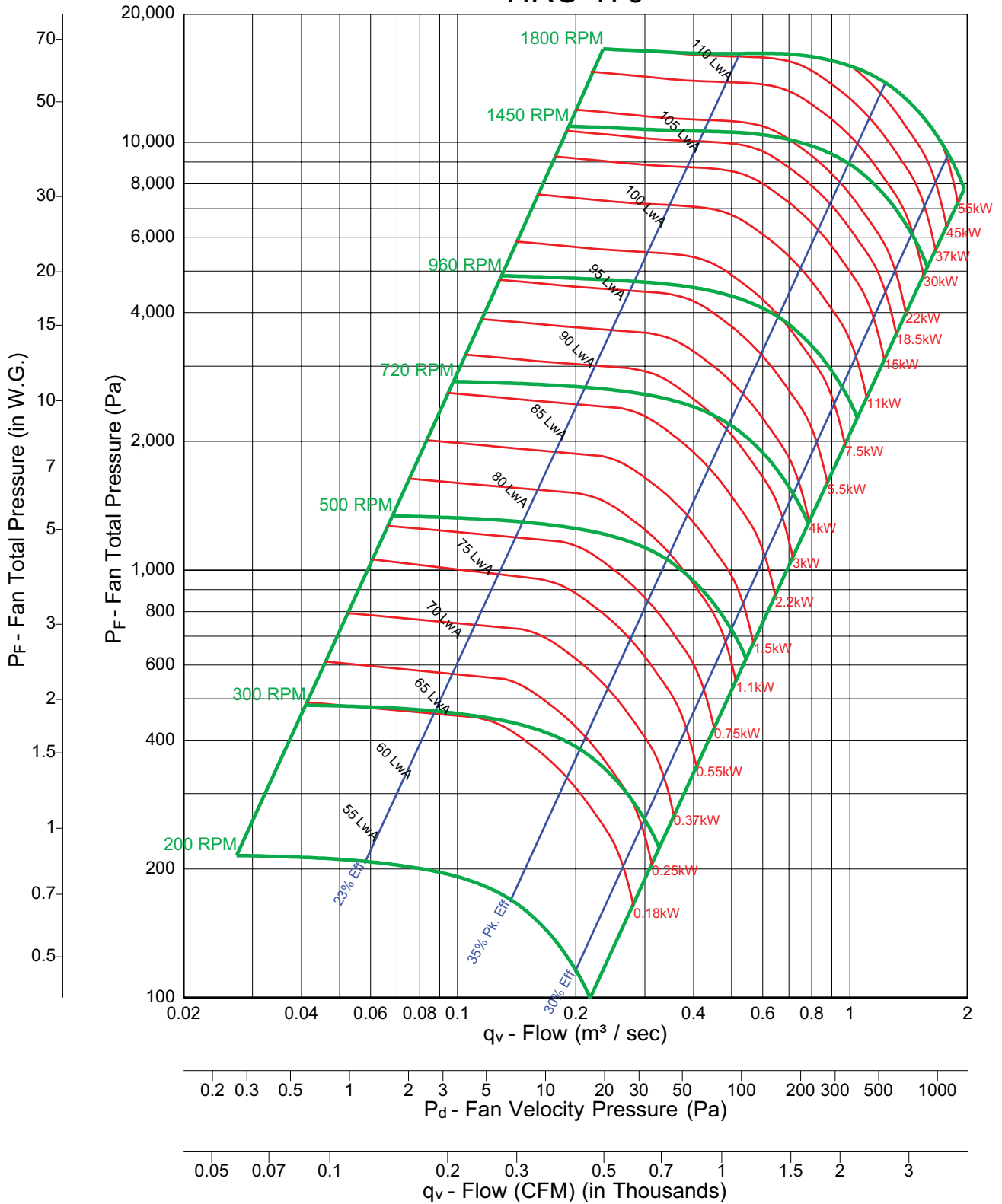

HRO 325

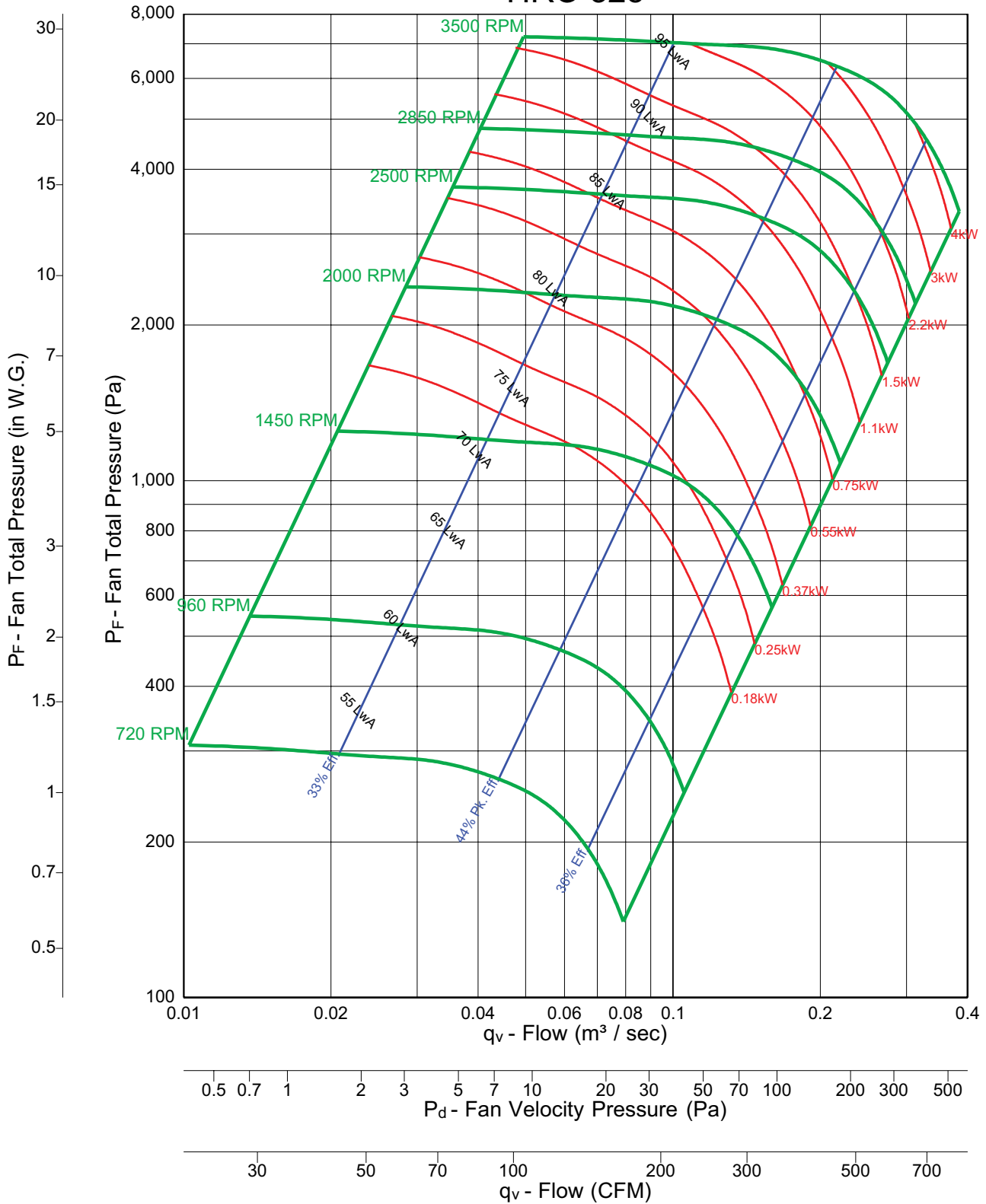

HRO 330

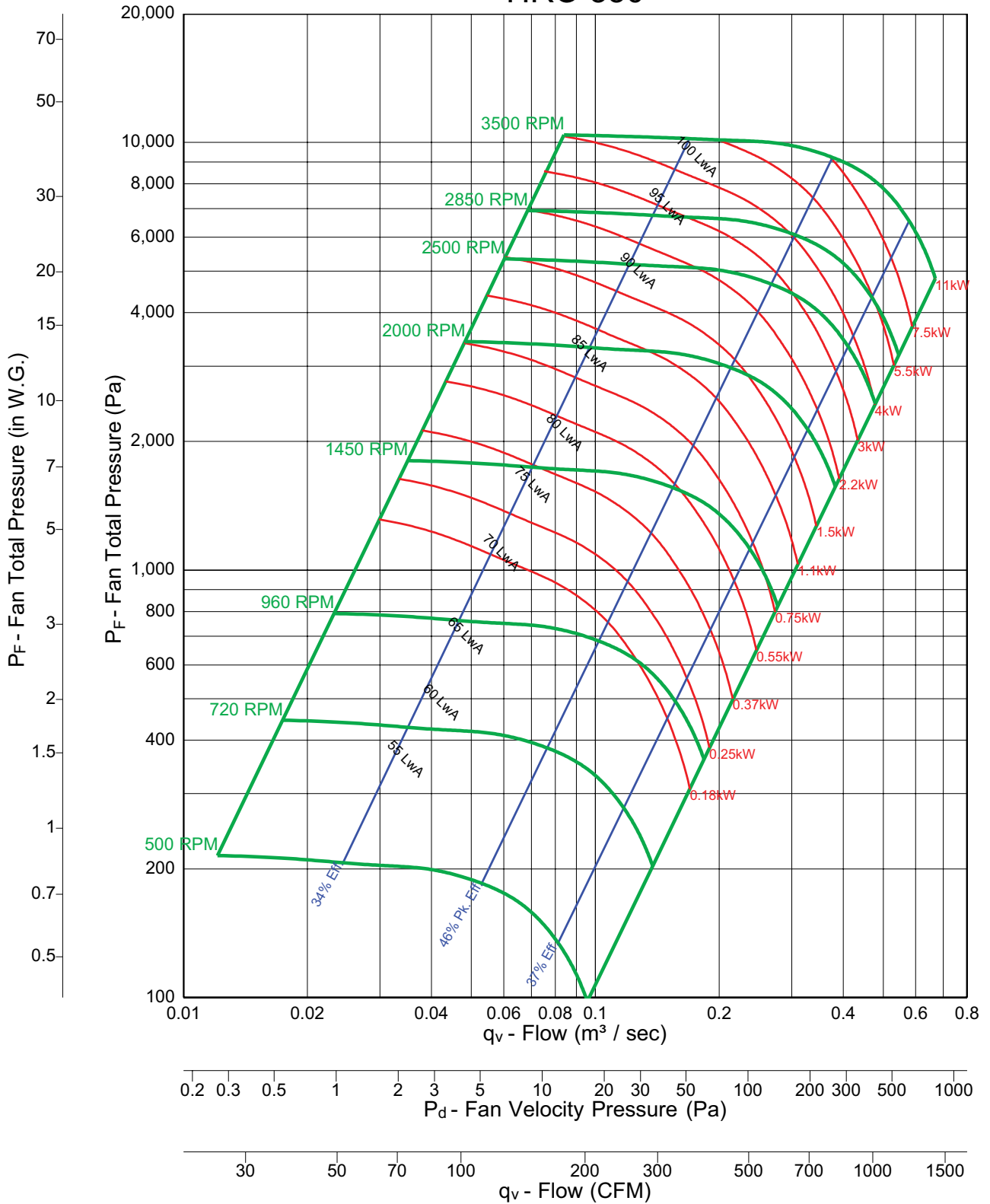

HRO 335

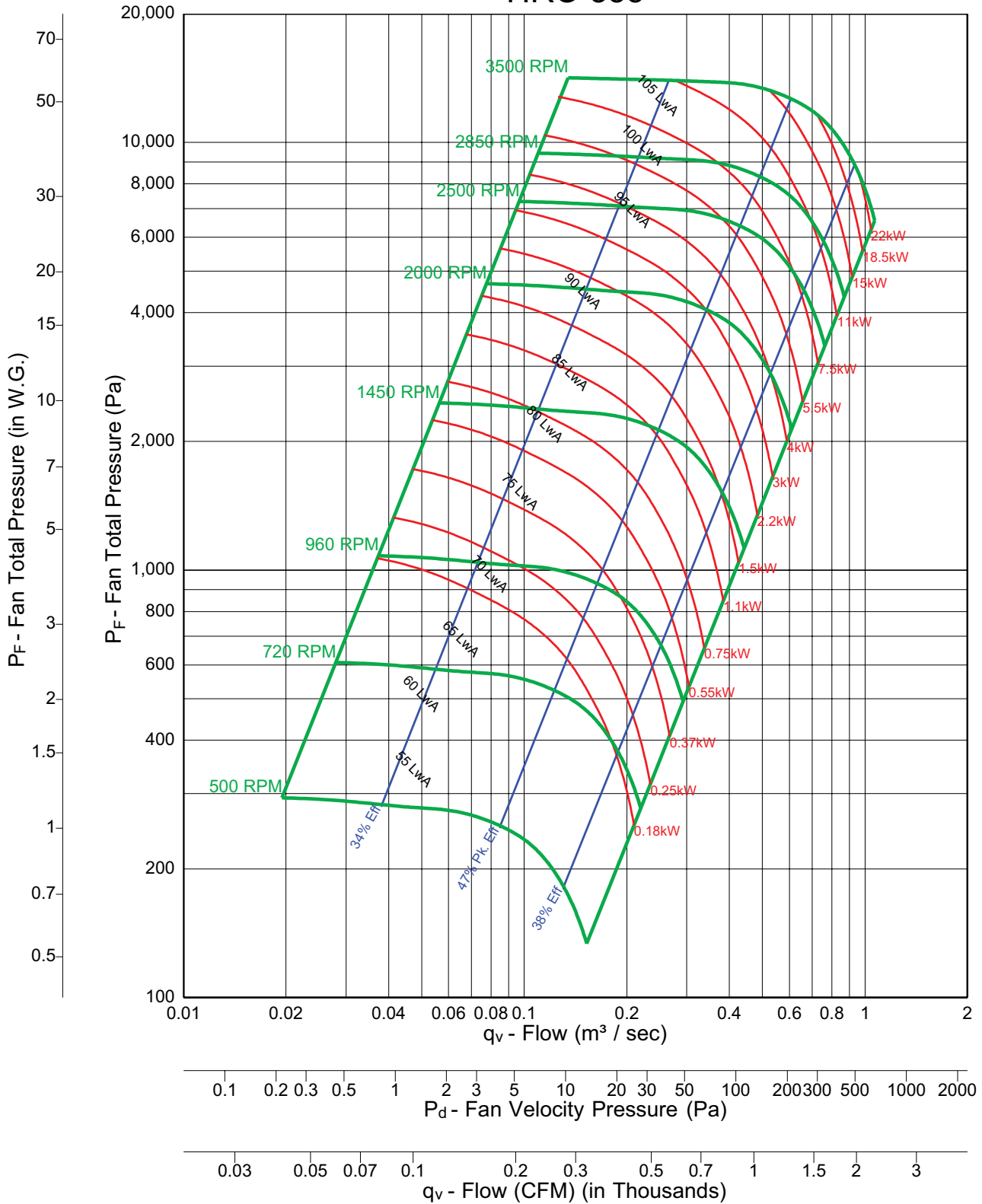

HRO 340

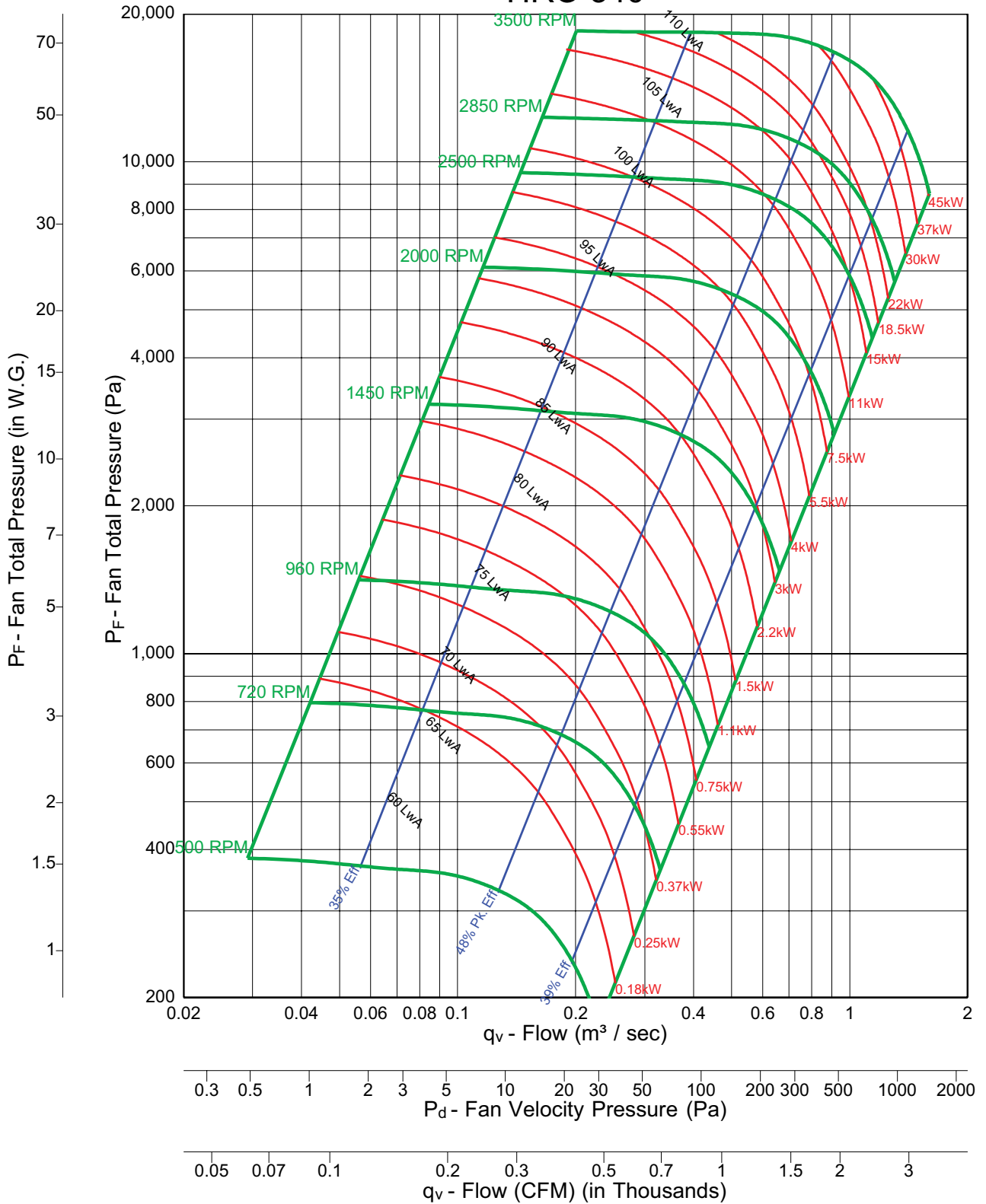

HRO 345

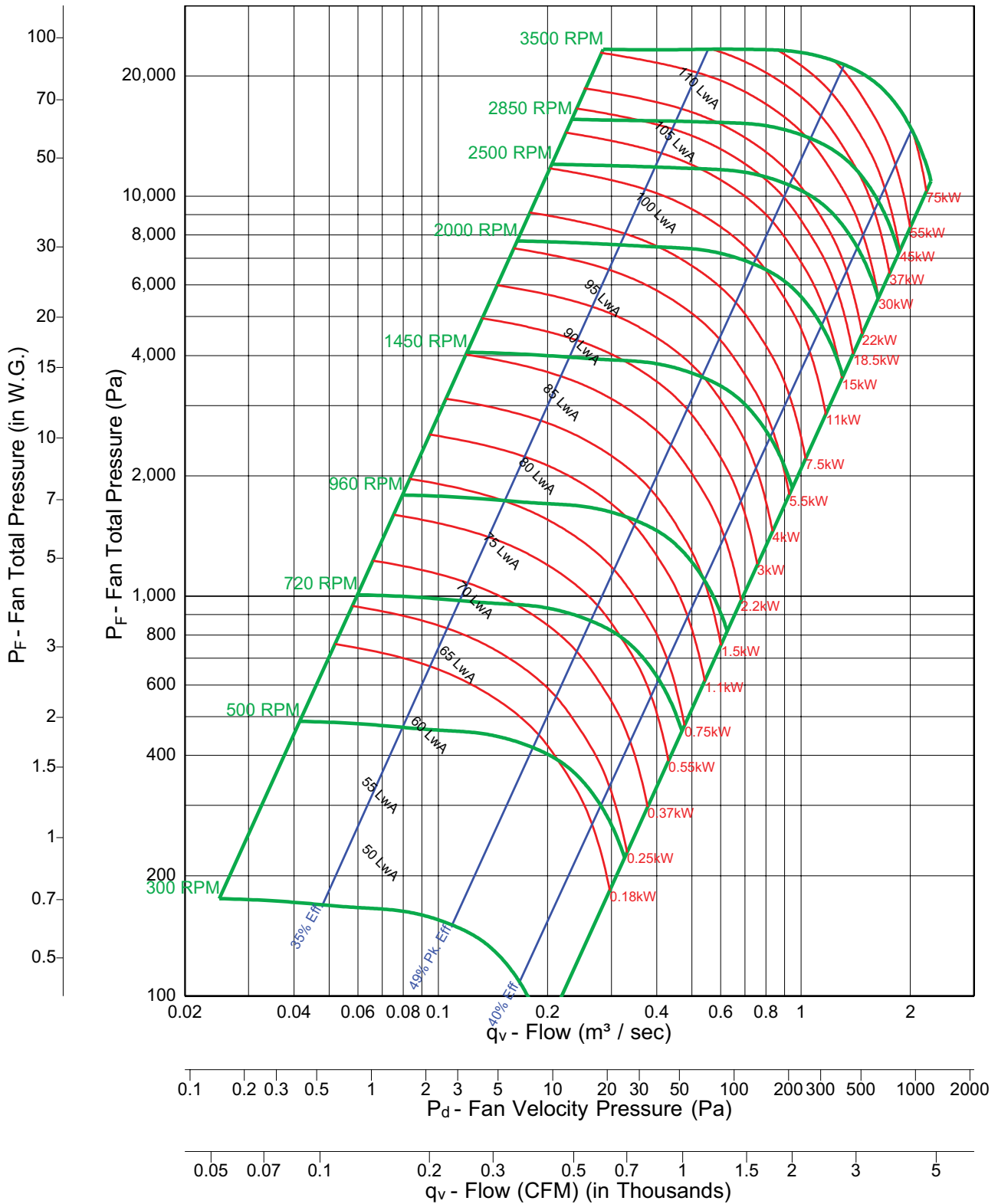

HRO 350

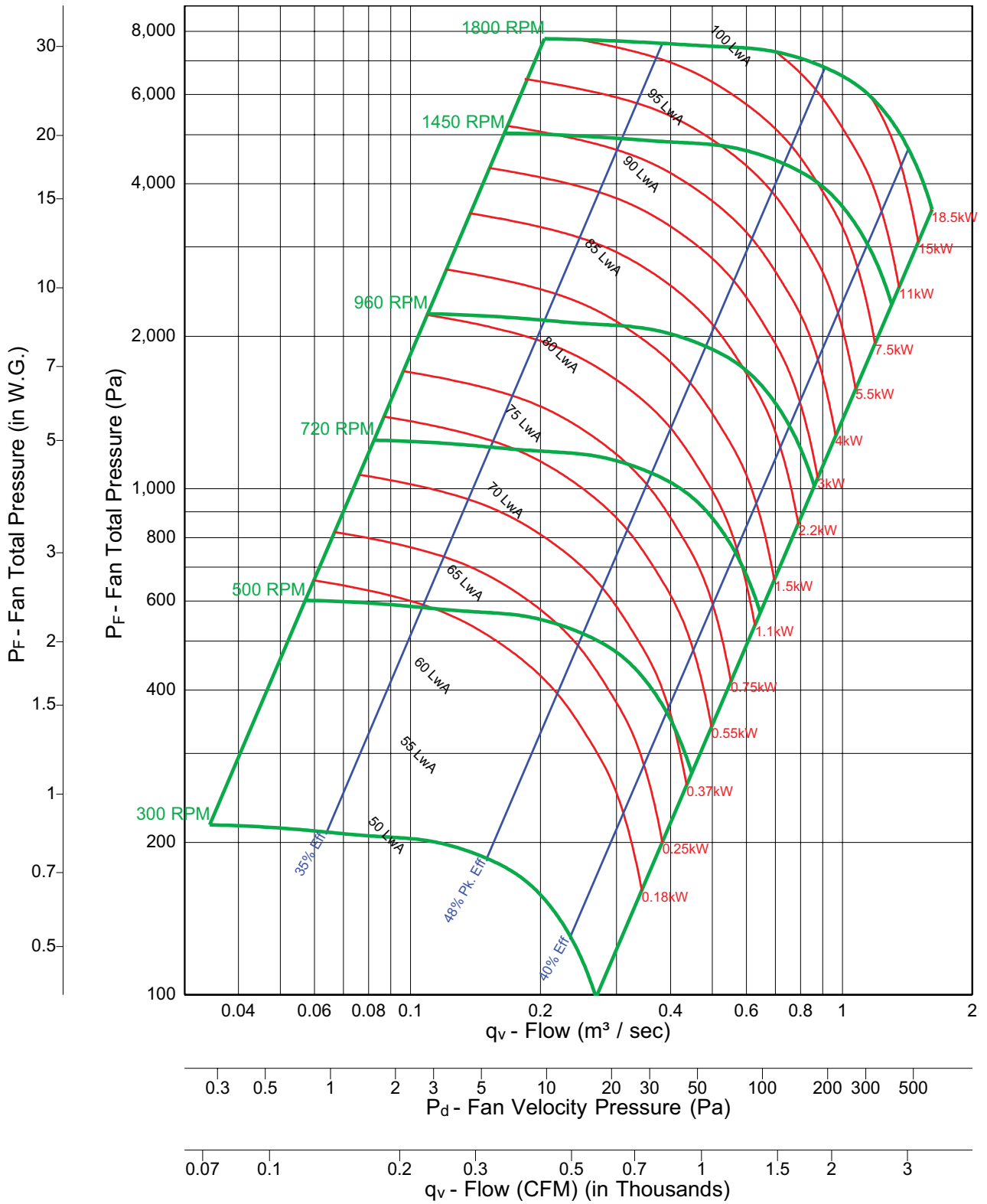

HRO 355

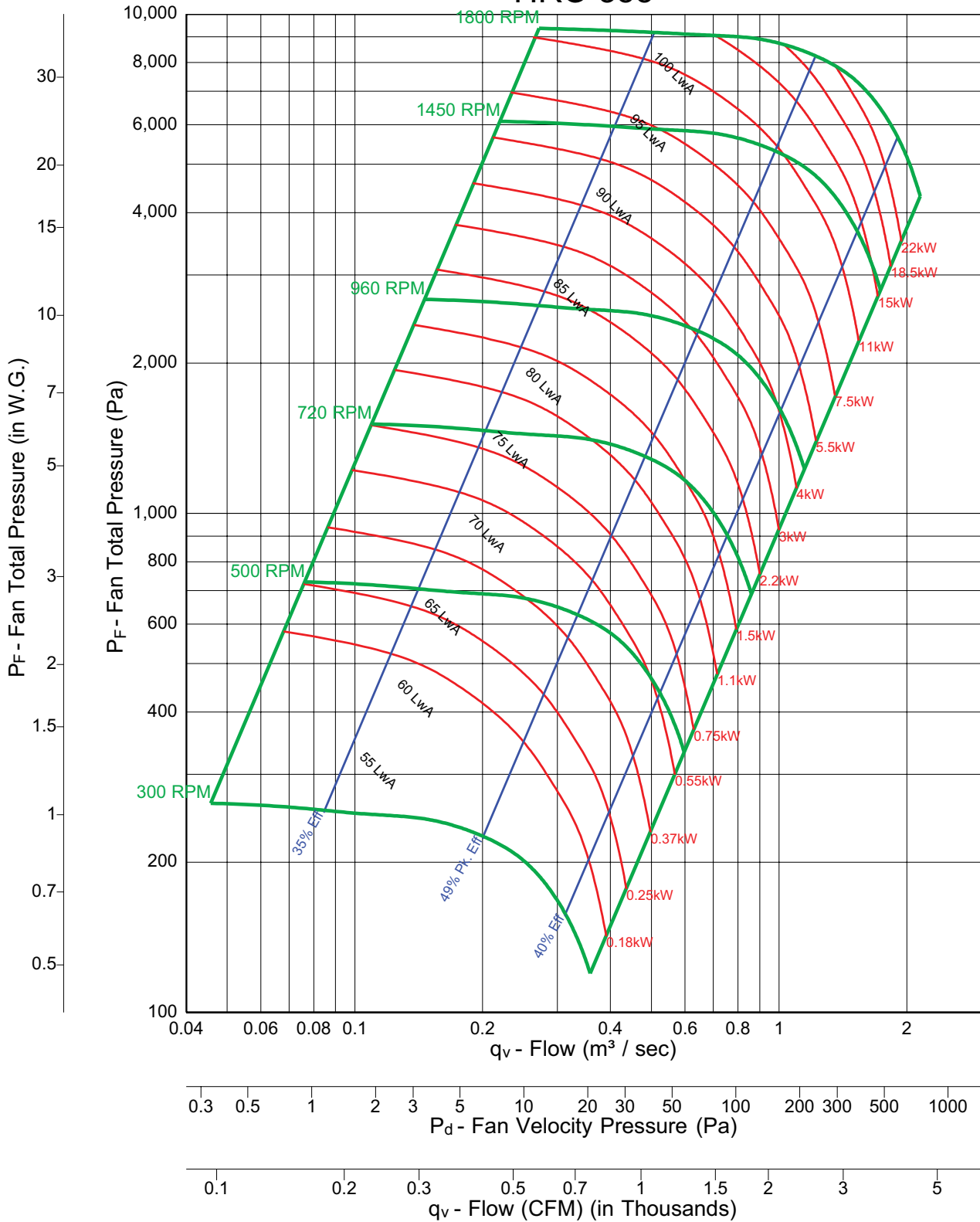

HRO 360

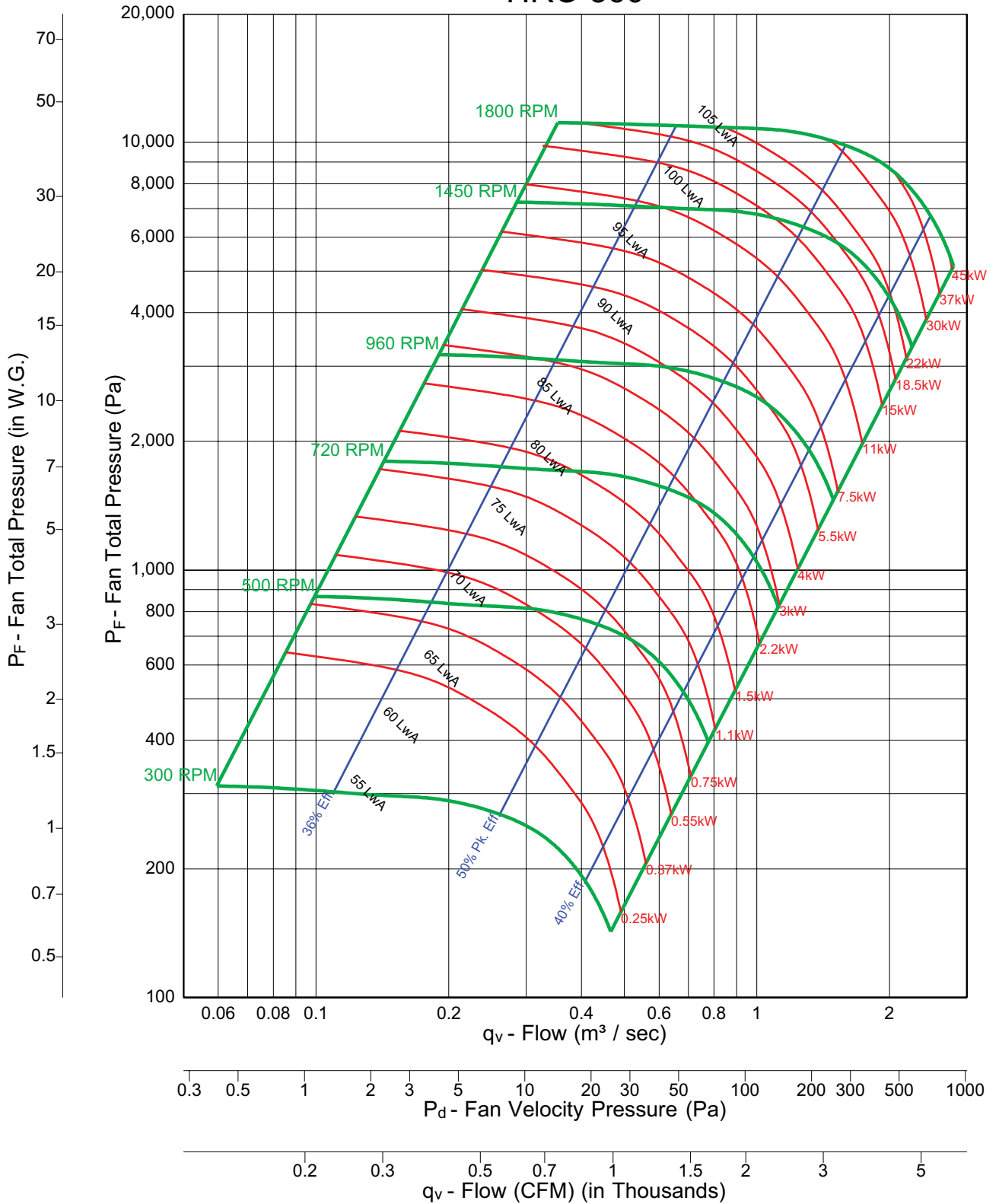

HRO 365

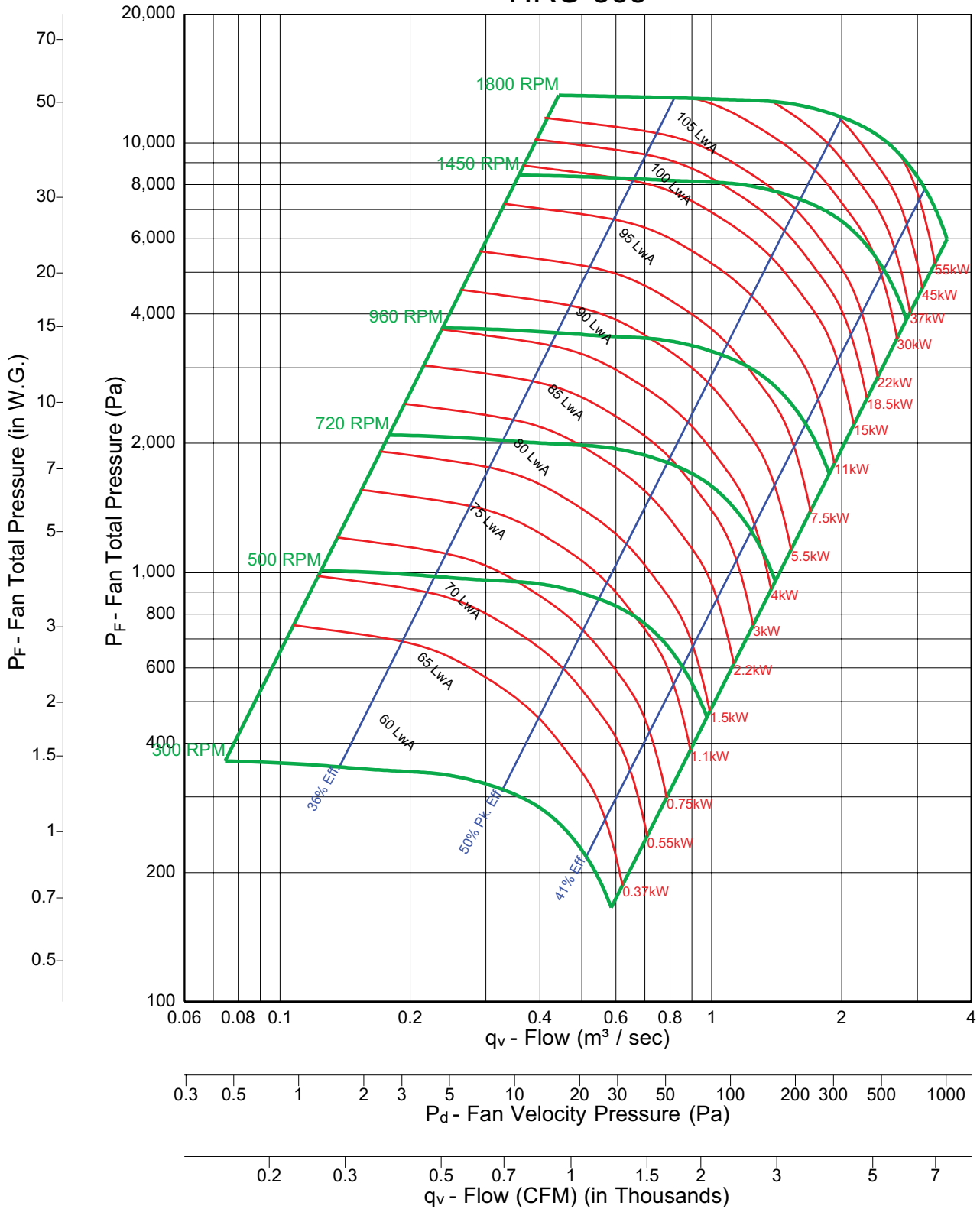

HRO 370

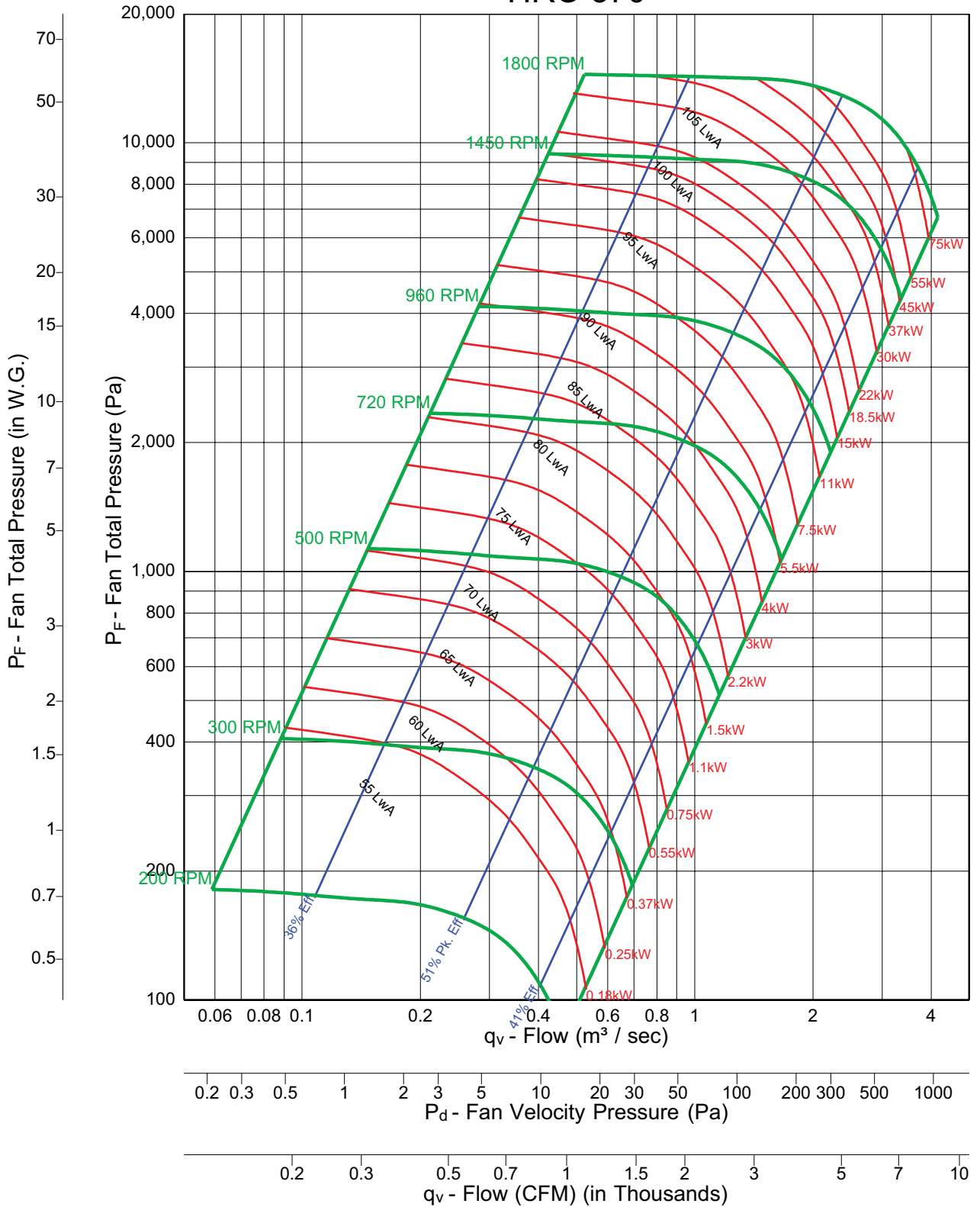

HRS 125

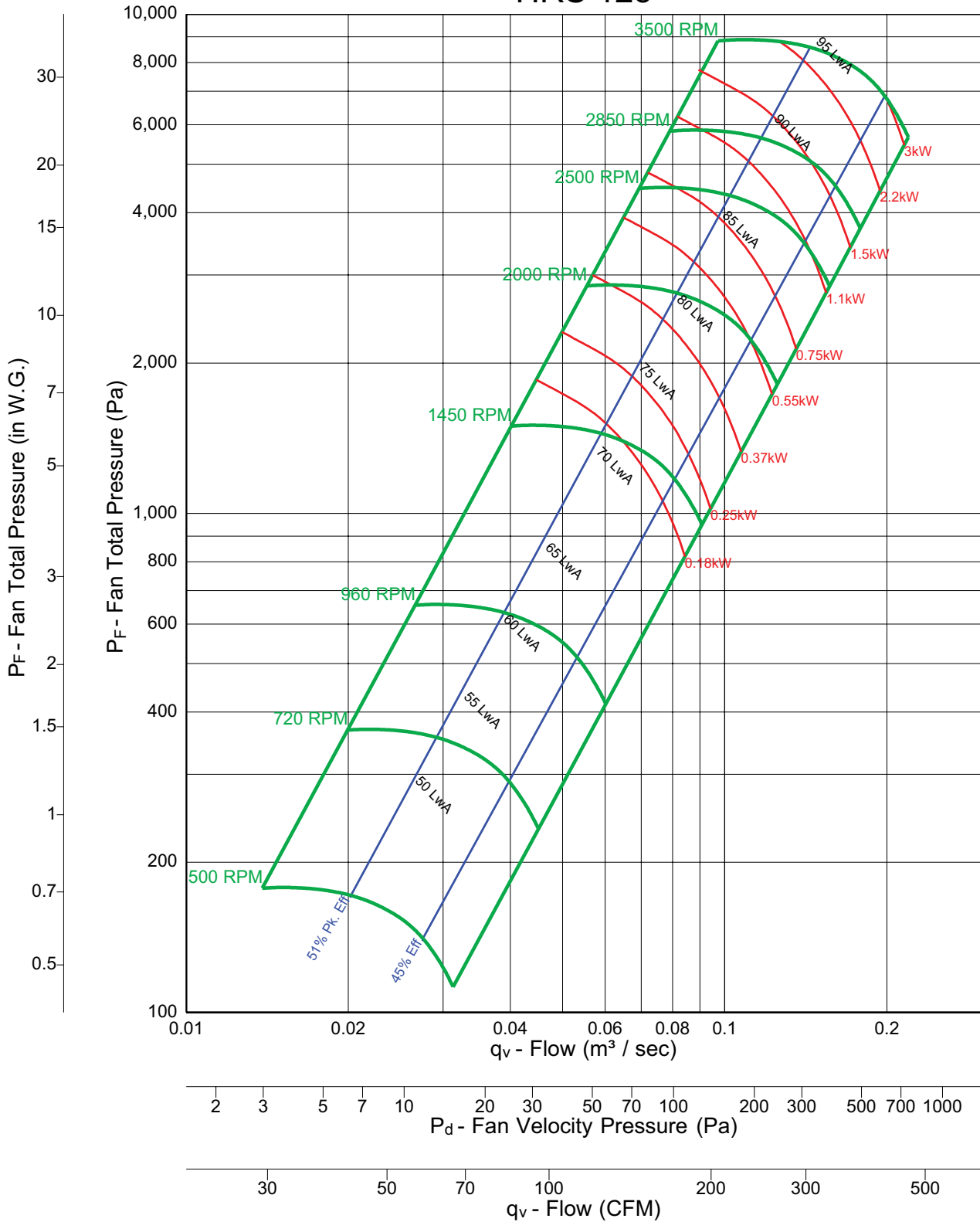

HRS 130

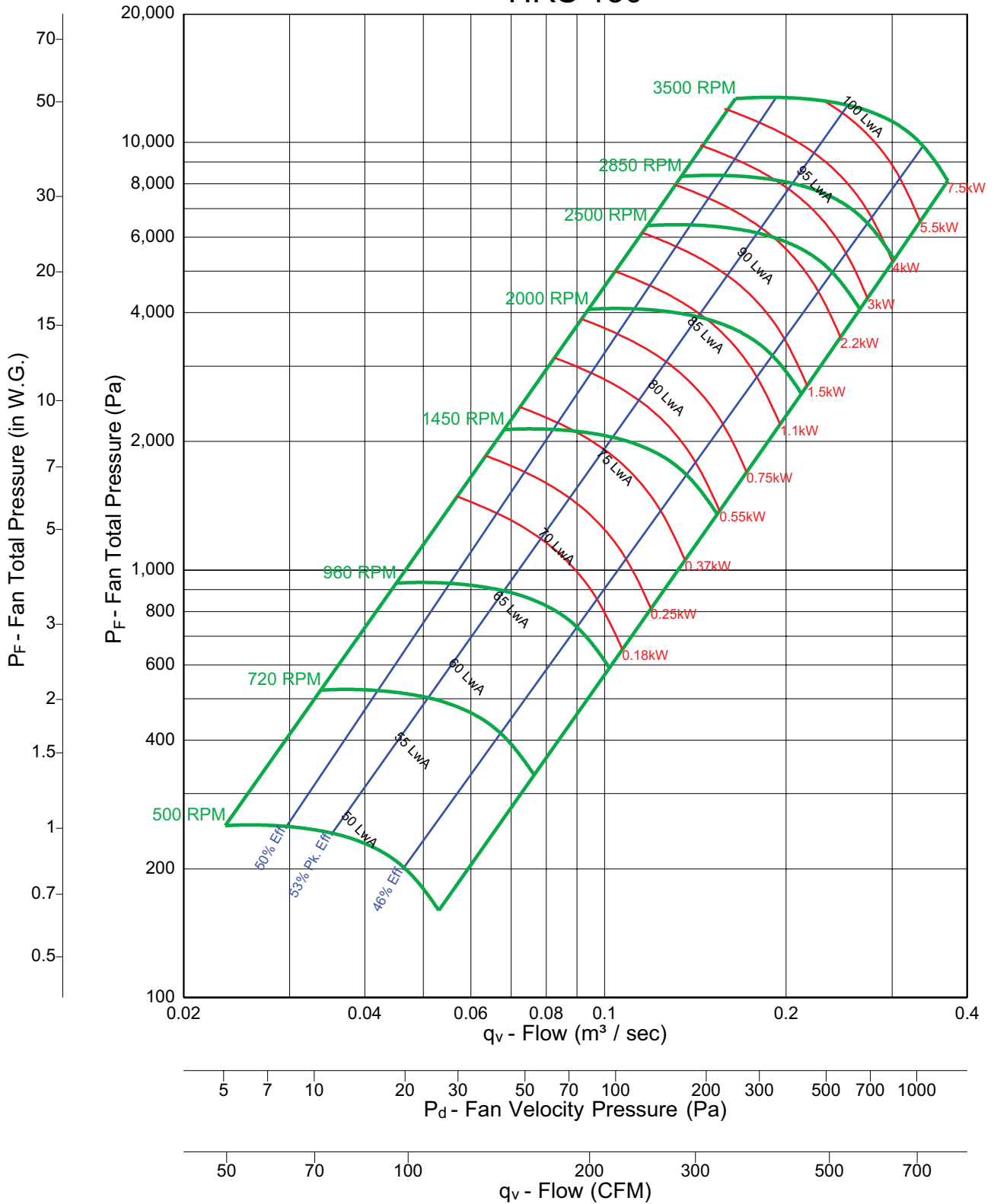

HRS 135

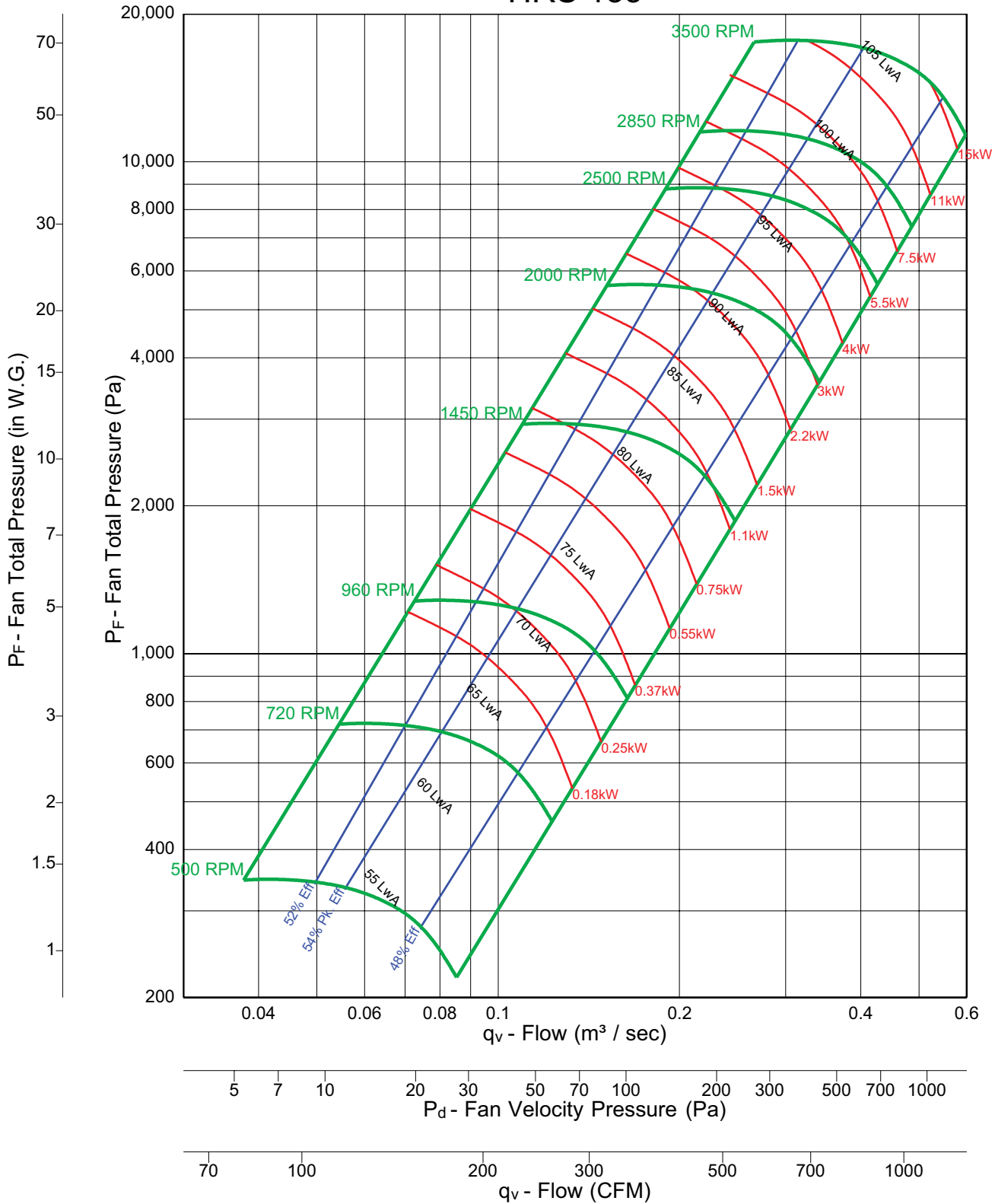

HRS 140

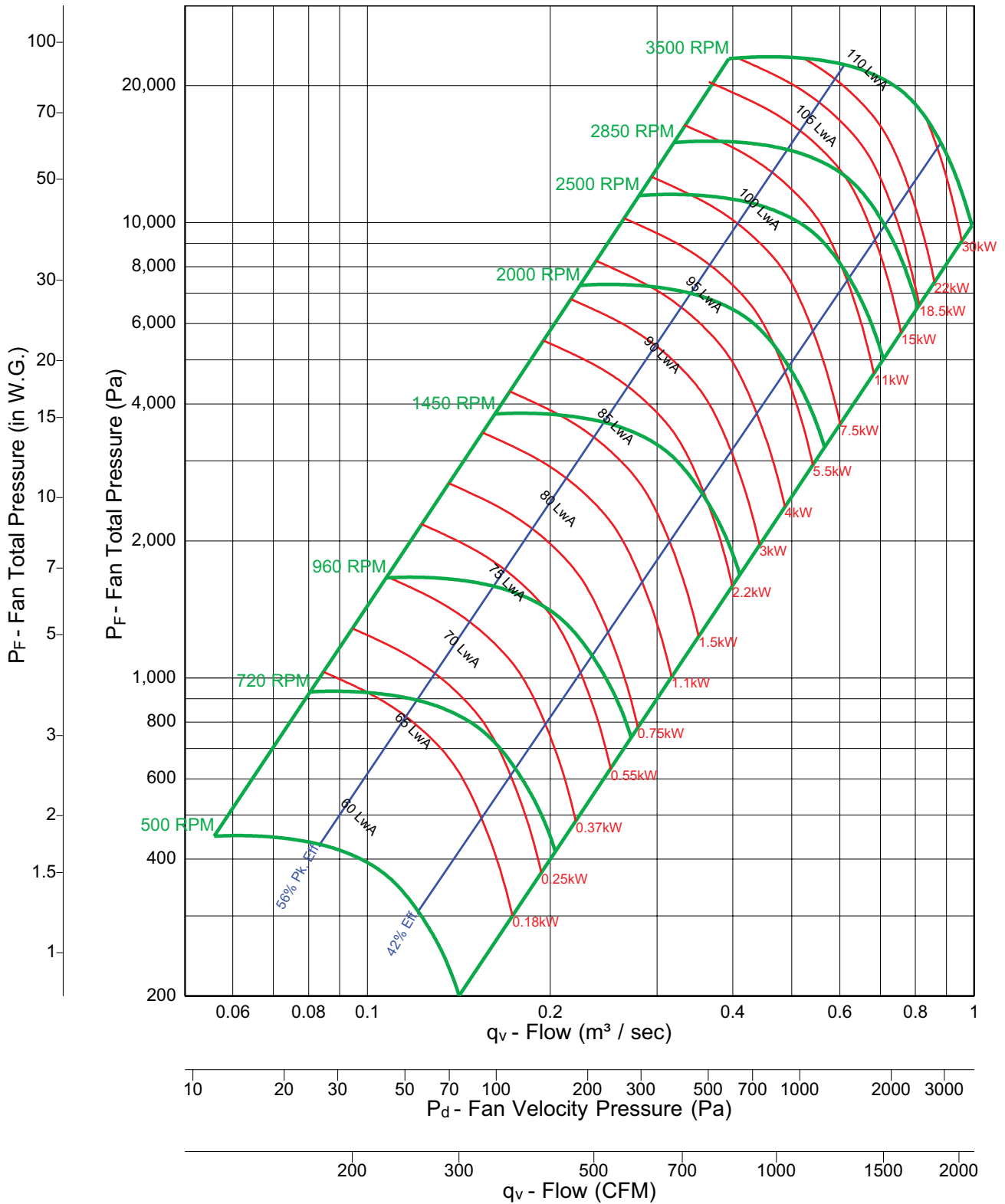

HRS 145

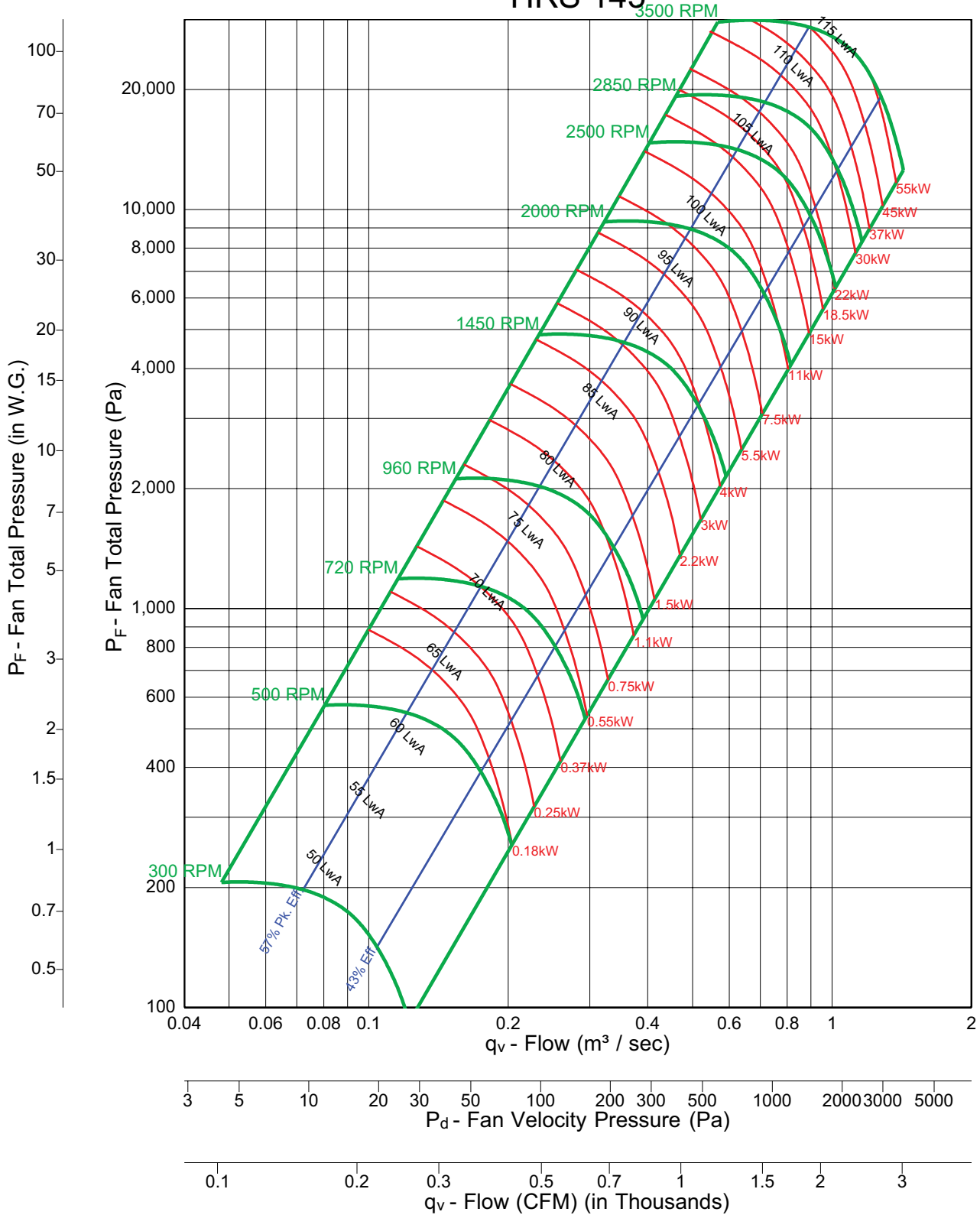

HRS 150

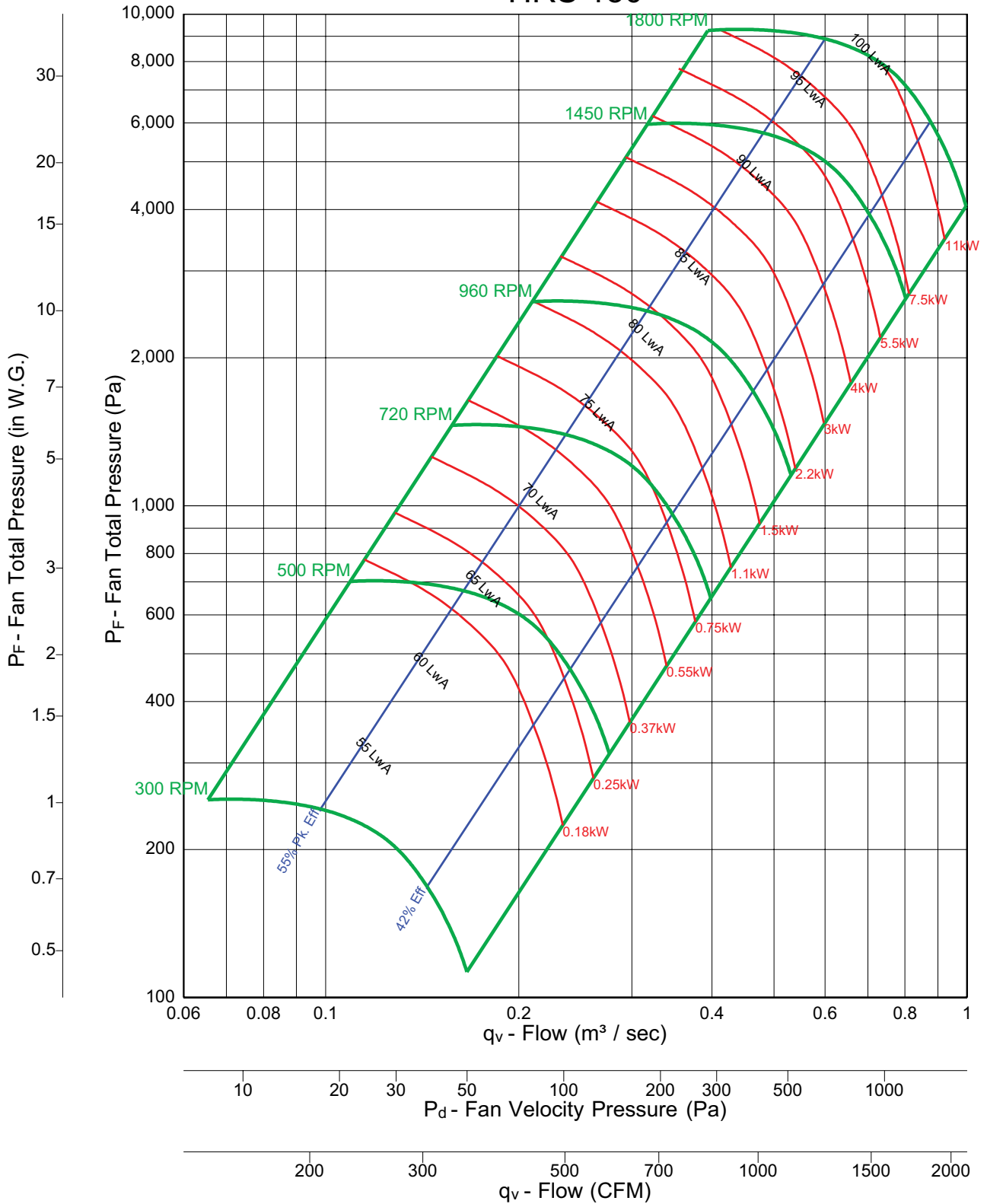

HRS 155

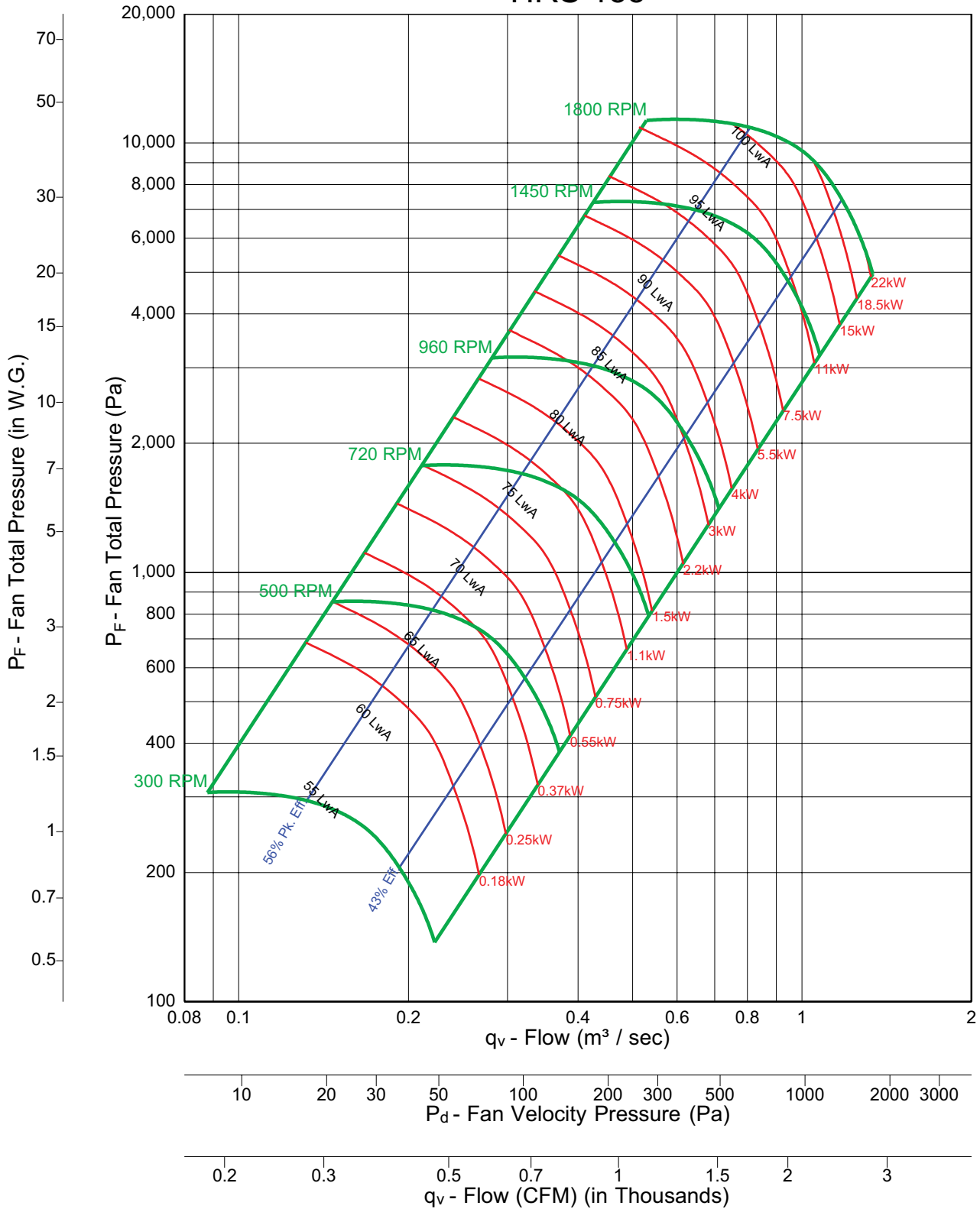

HRS 160

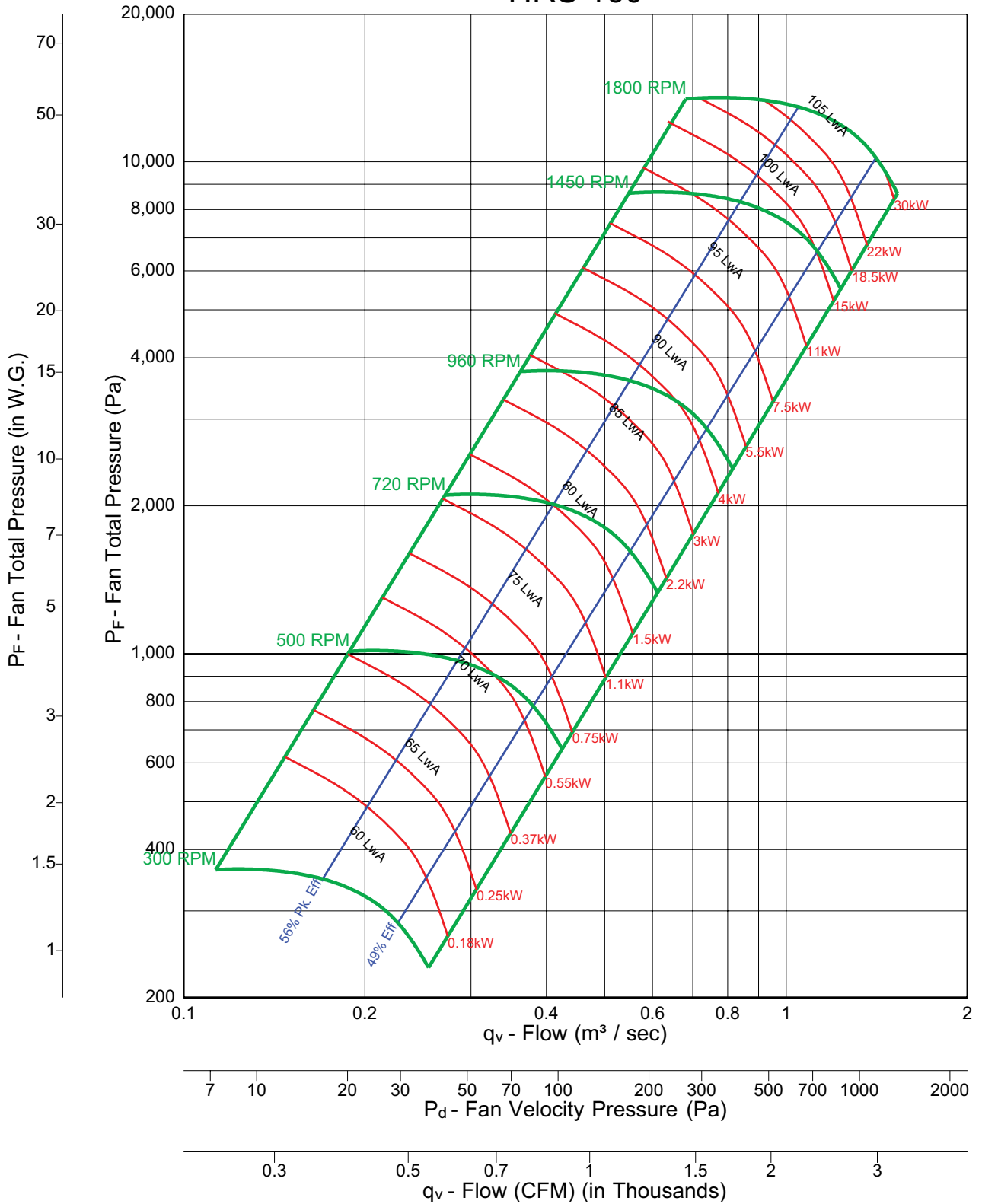

HRS 165

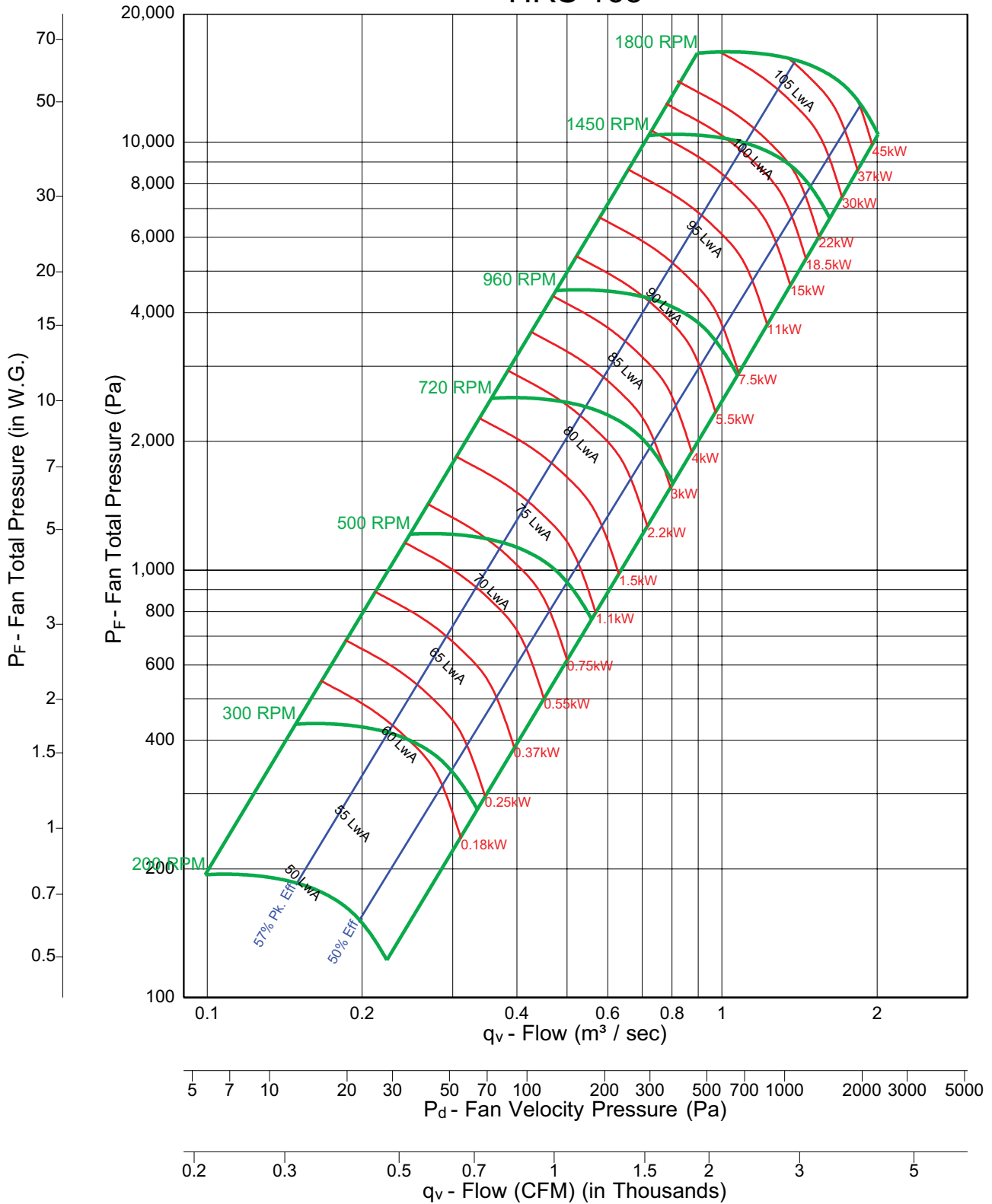

HRS 170

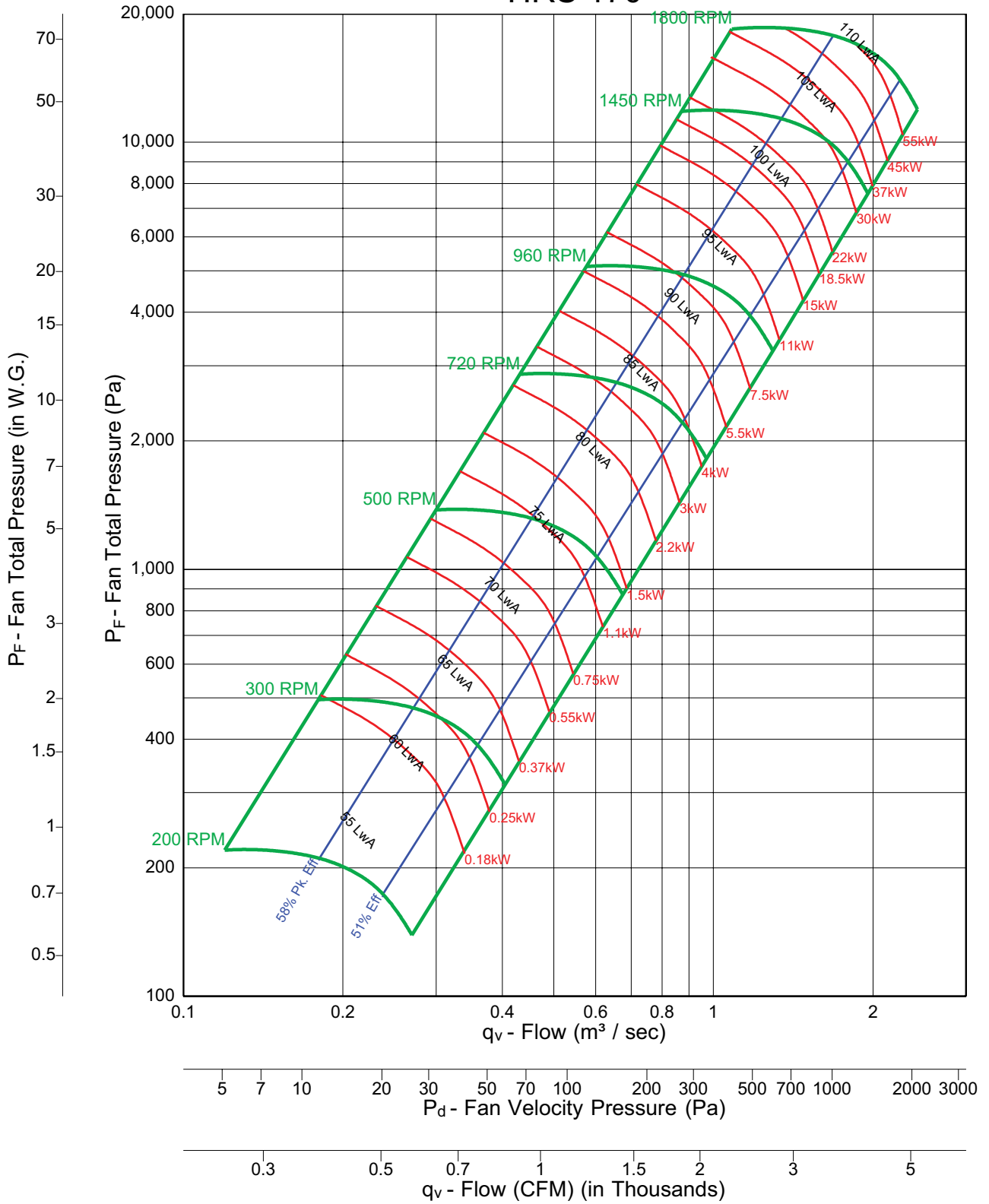

HRS 225

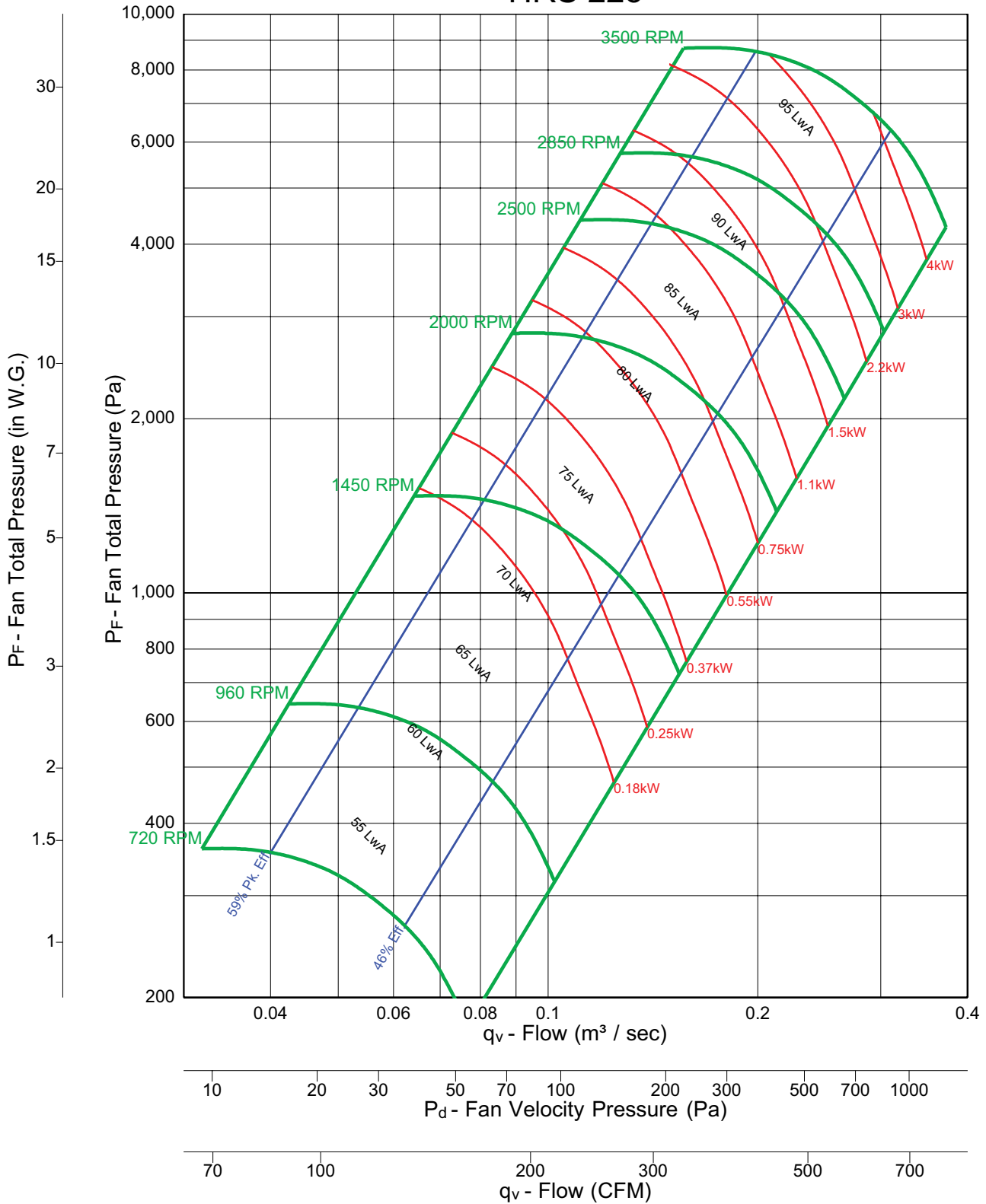

HRS 230

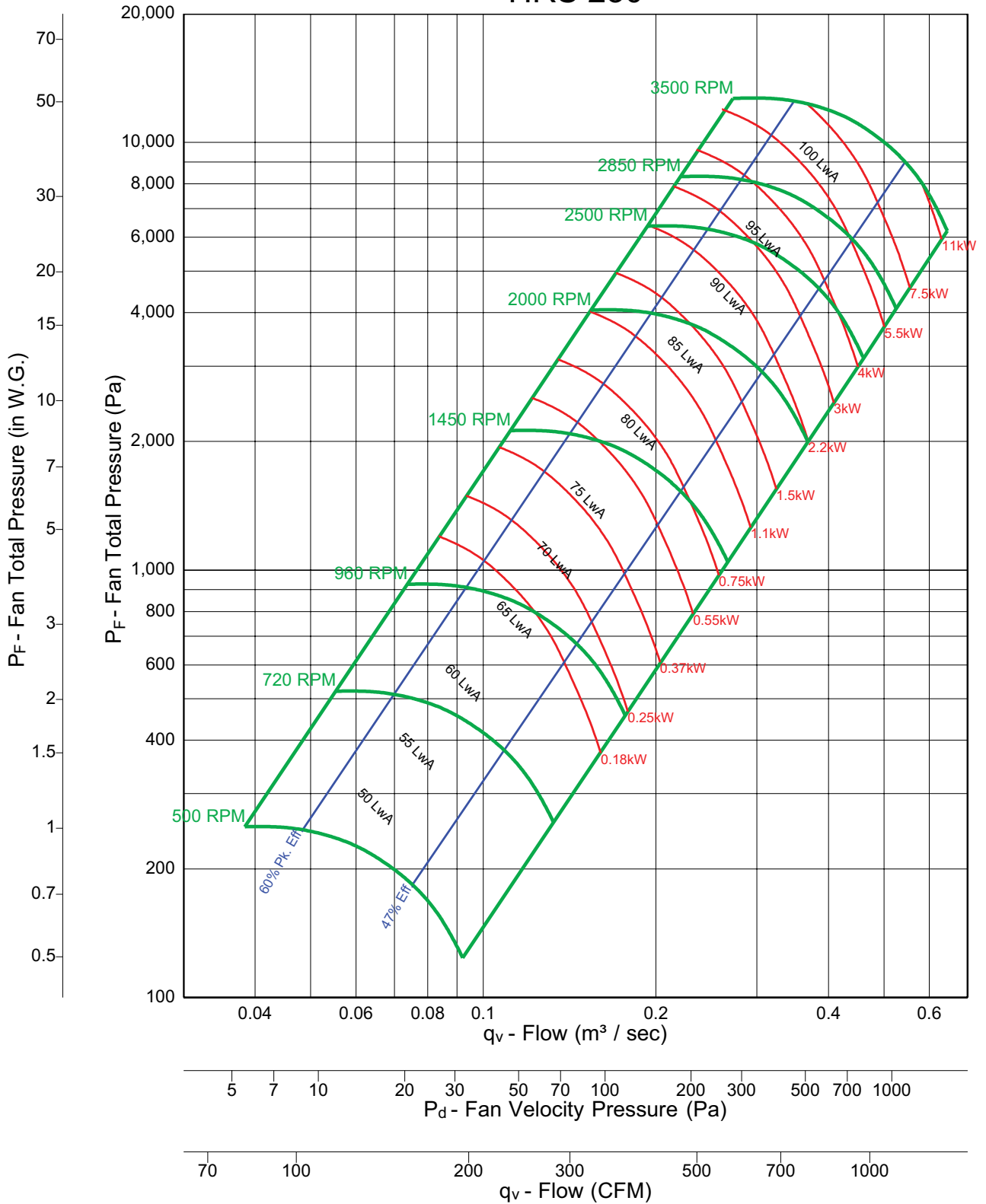

HRS 235

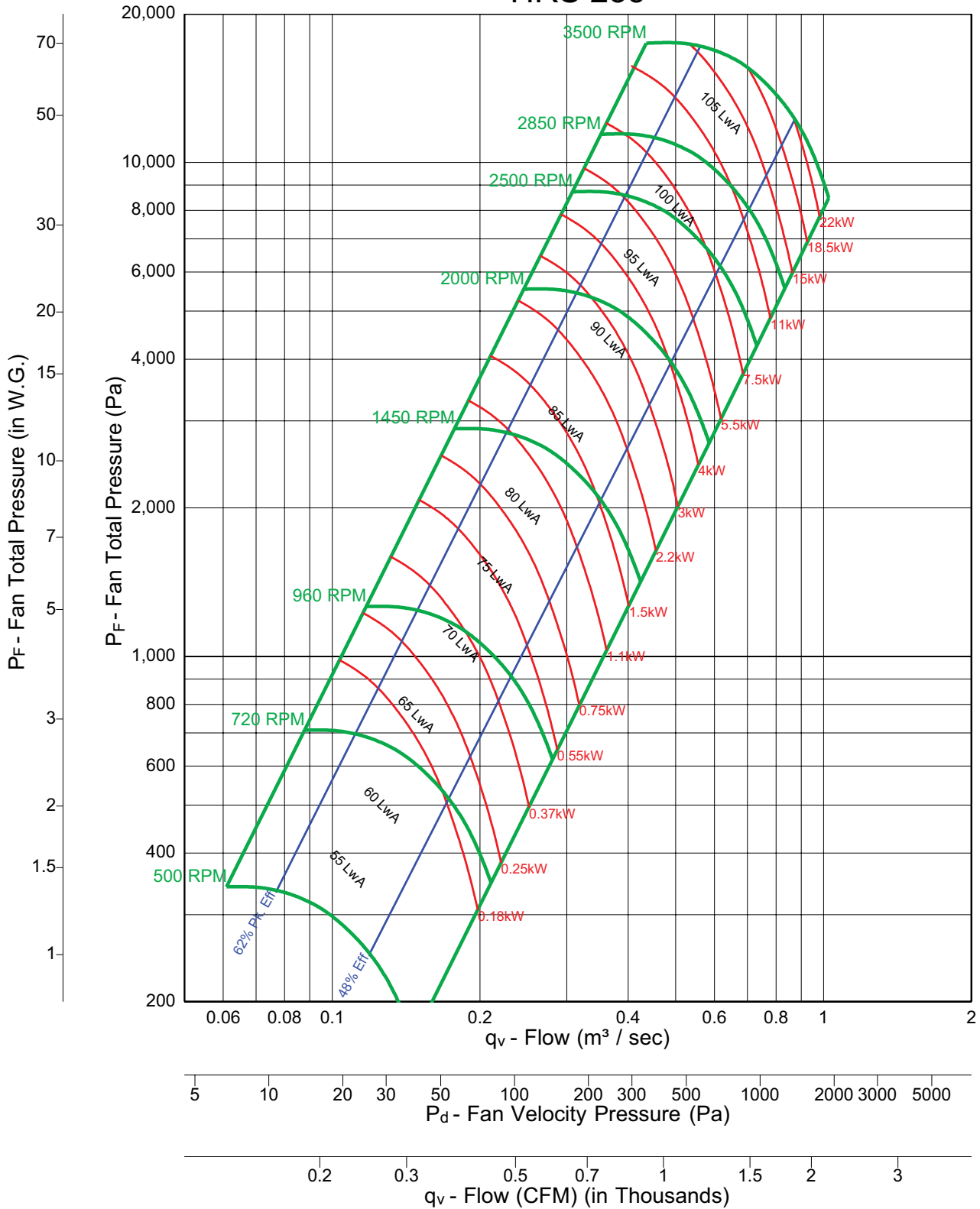

HRS 240

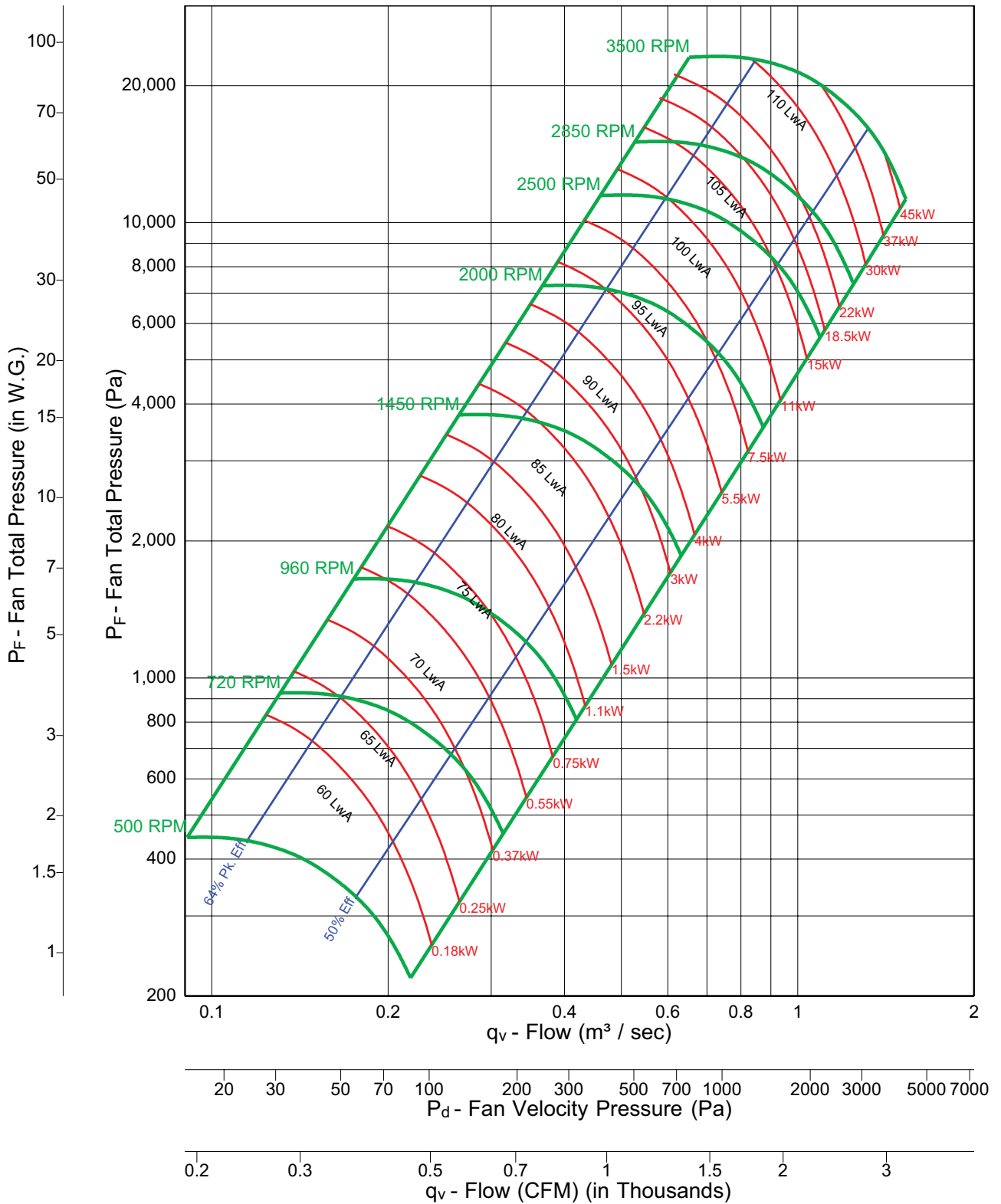

HRS 245

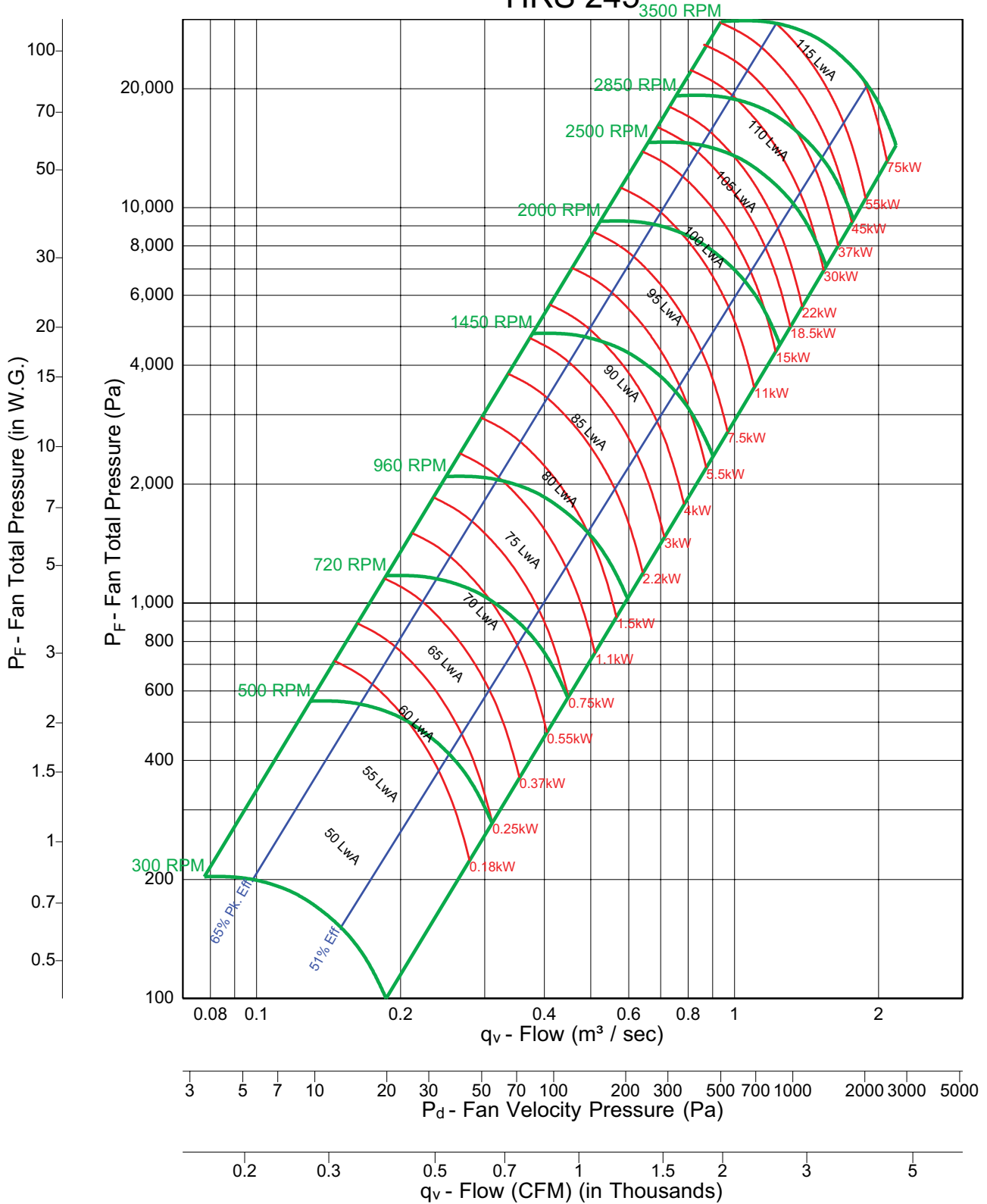

HRS 250

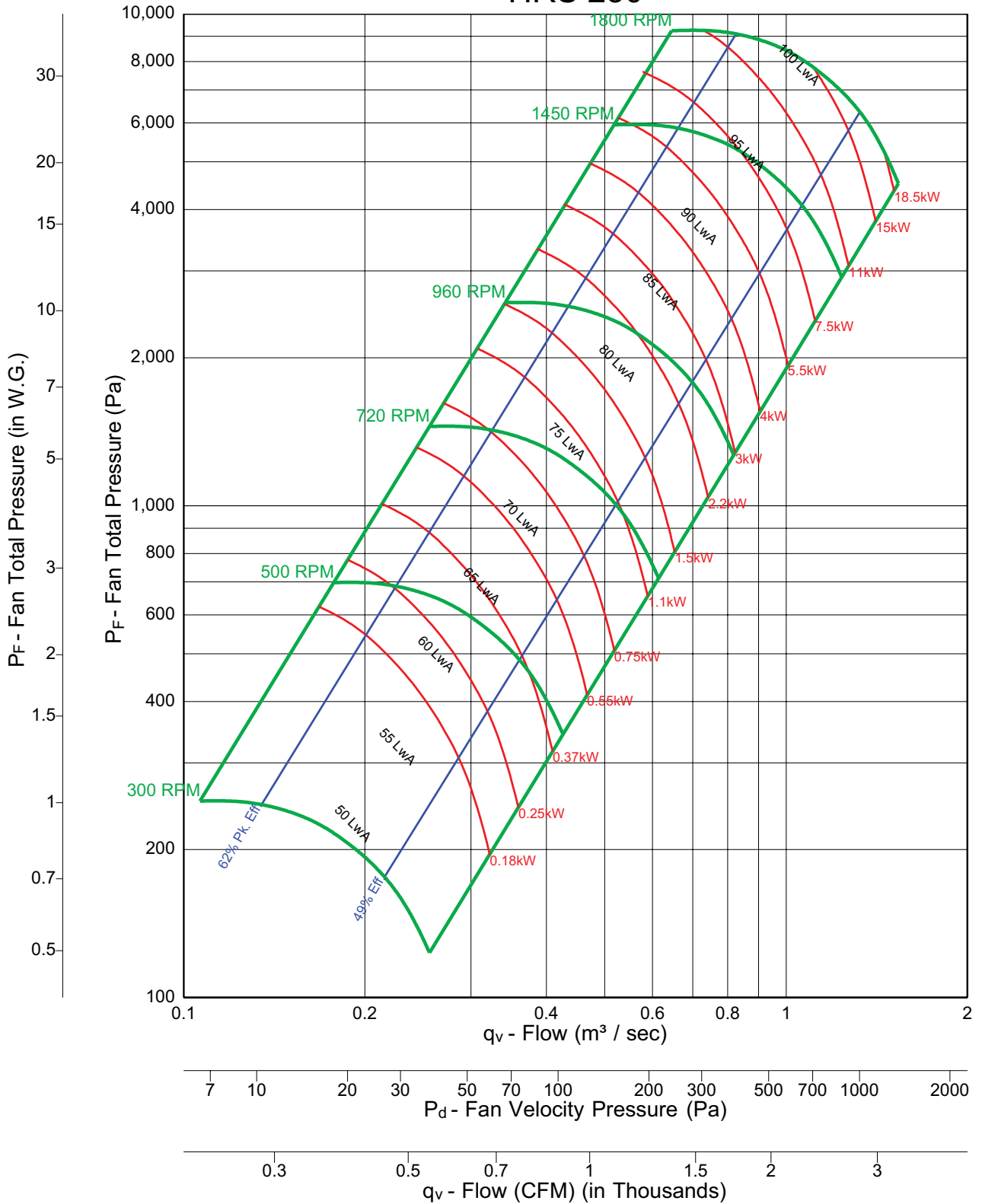

HRS 255

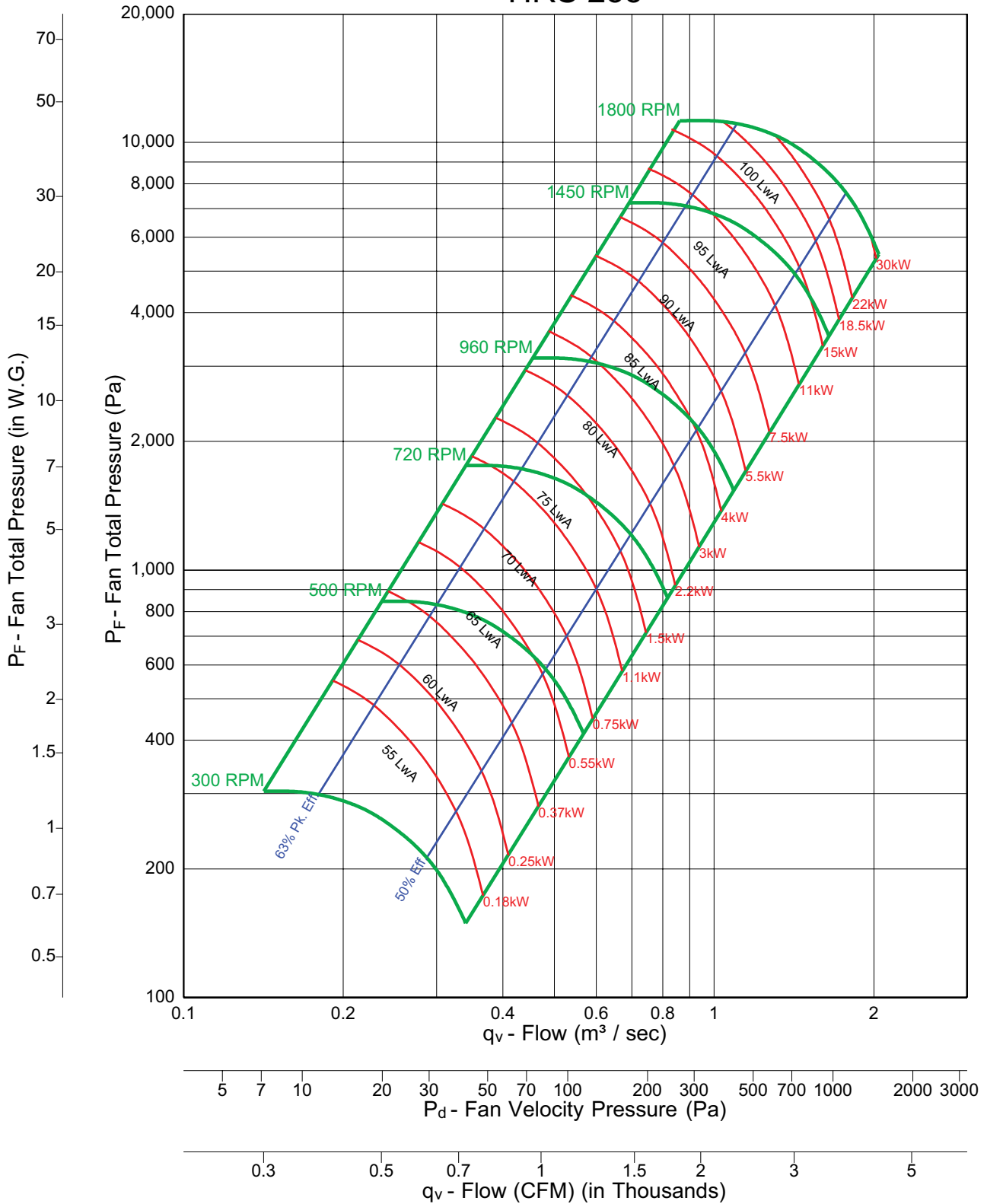

HRS 260

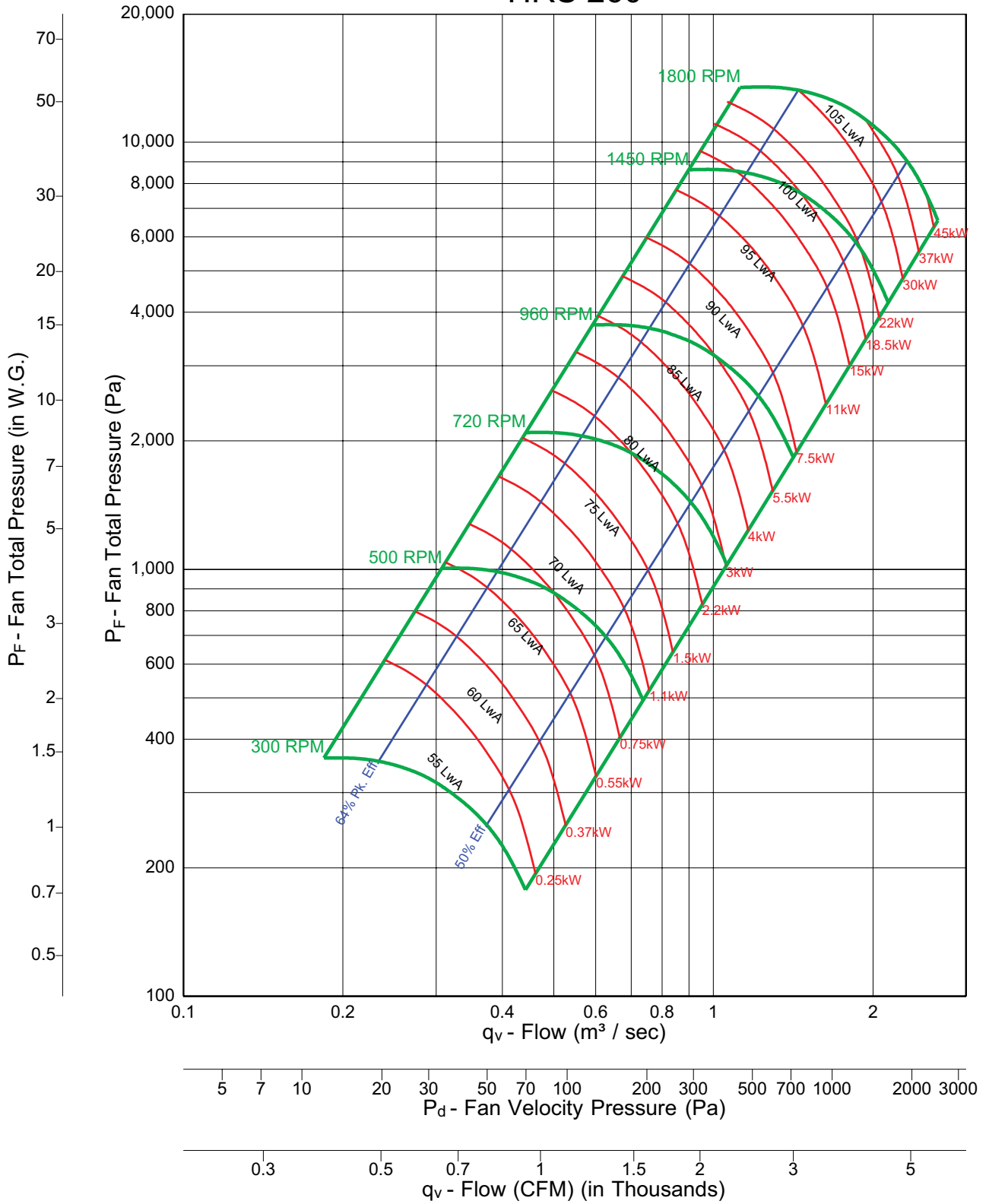

HRS 265

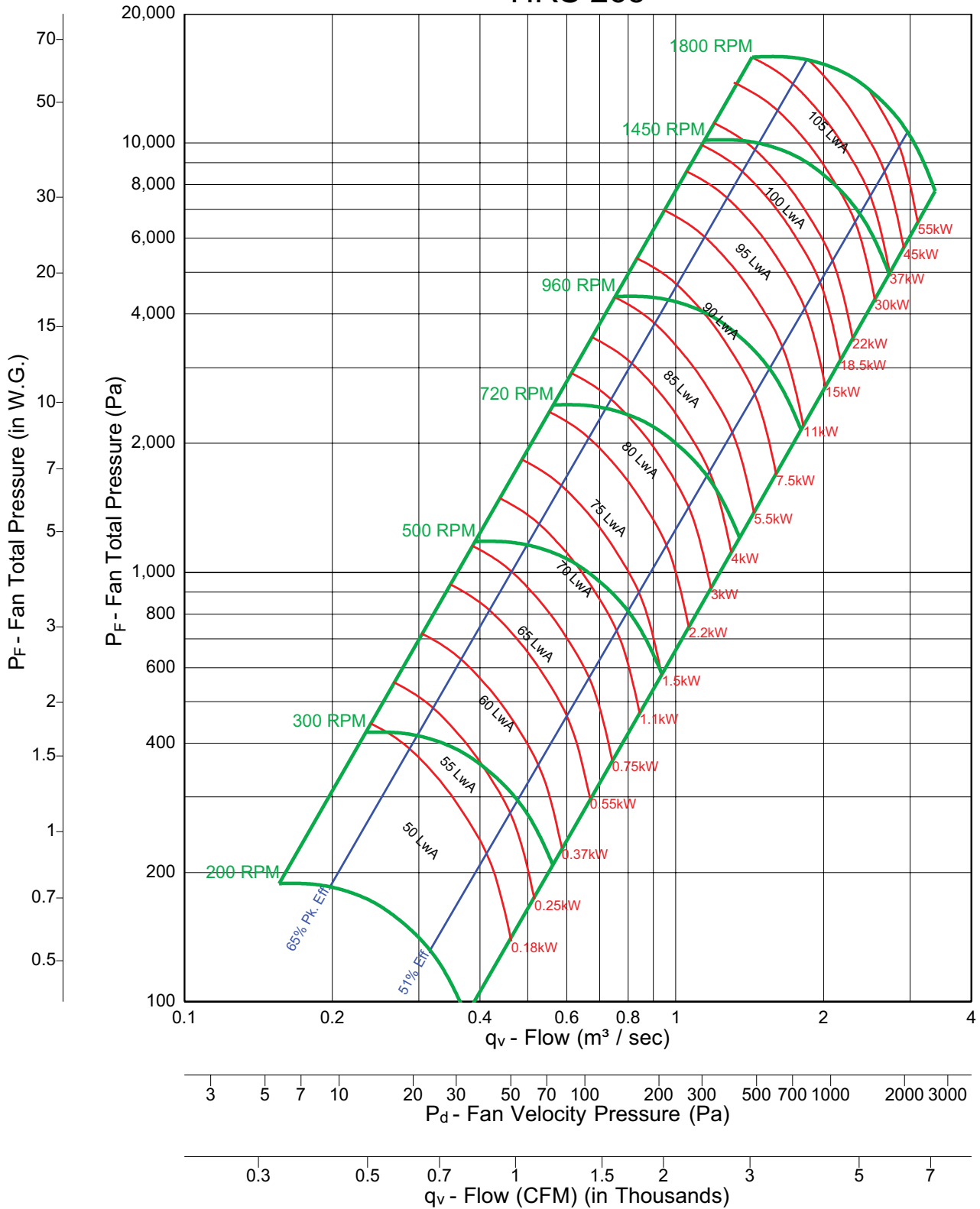

HRS 270

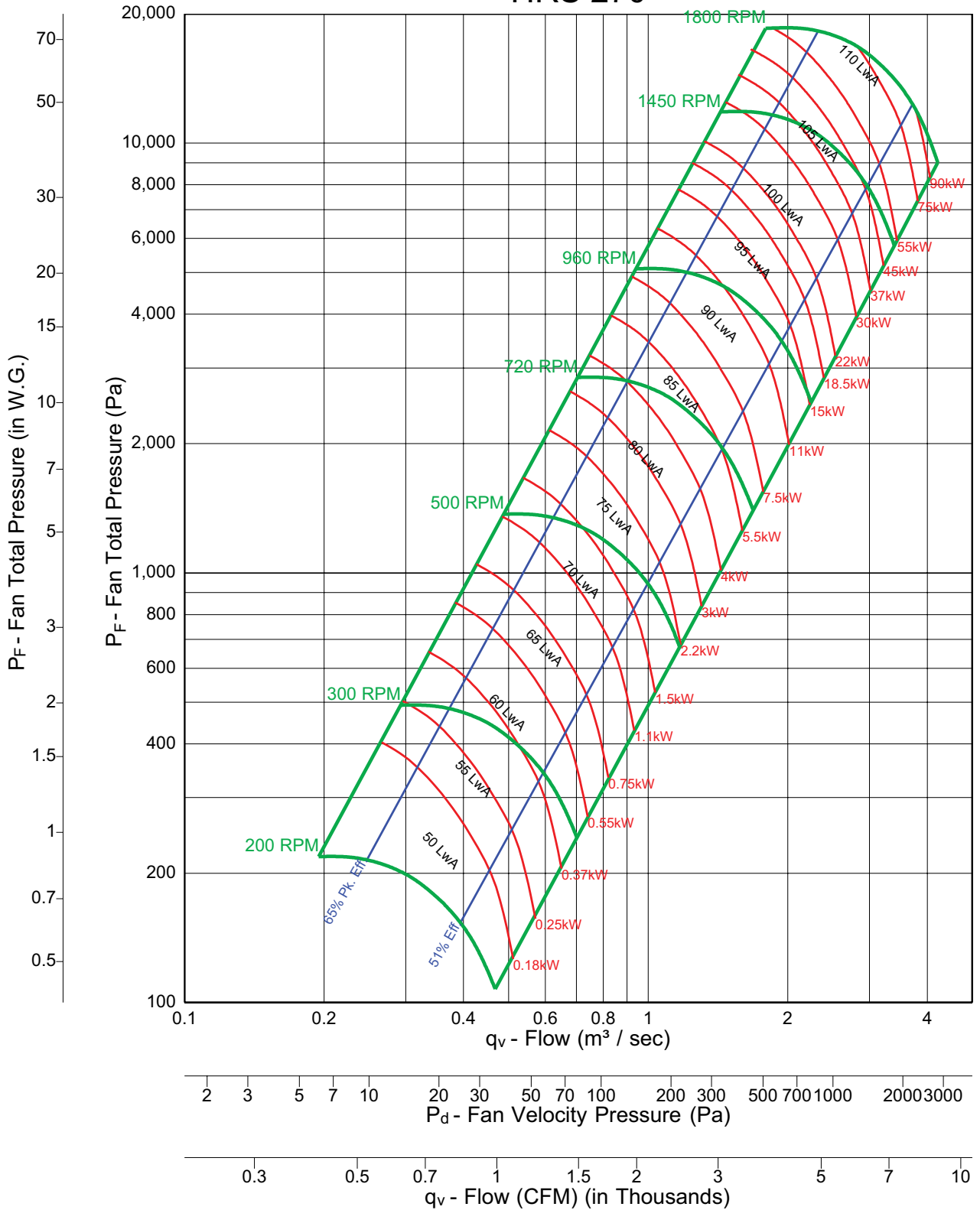

HRS 325

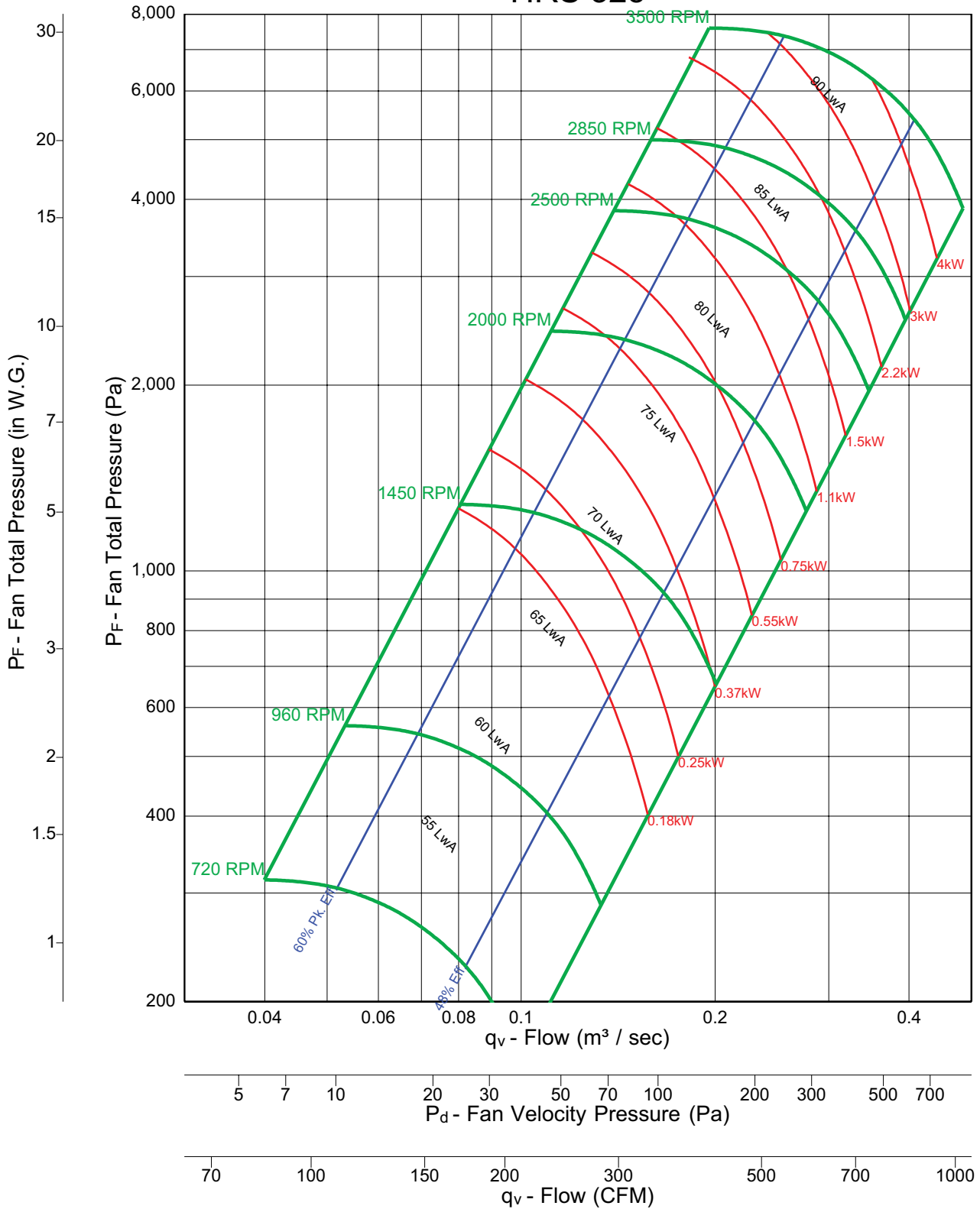

HRS 330

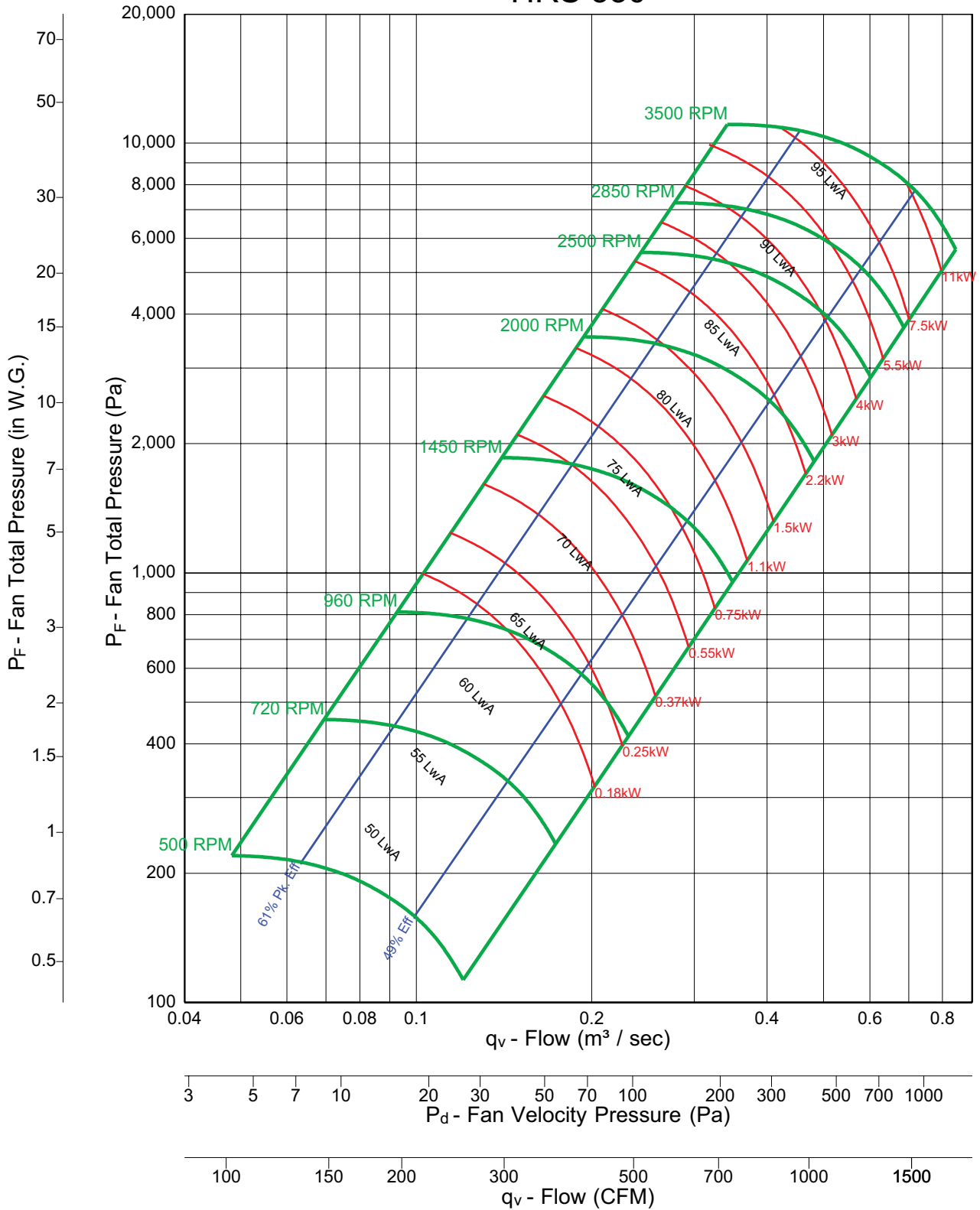

HRS 335

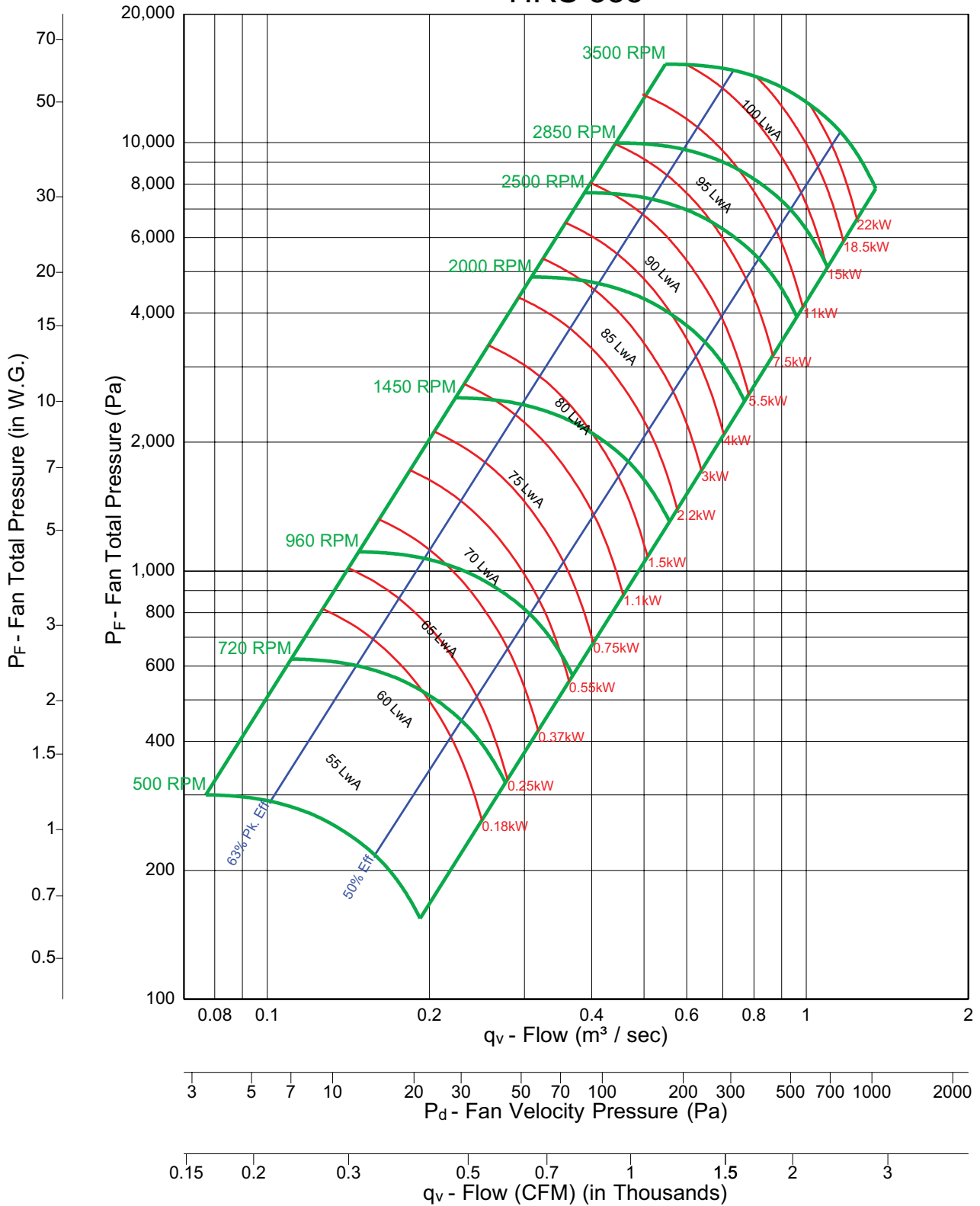

HRS 340

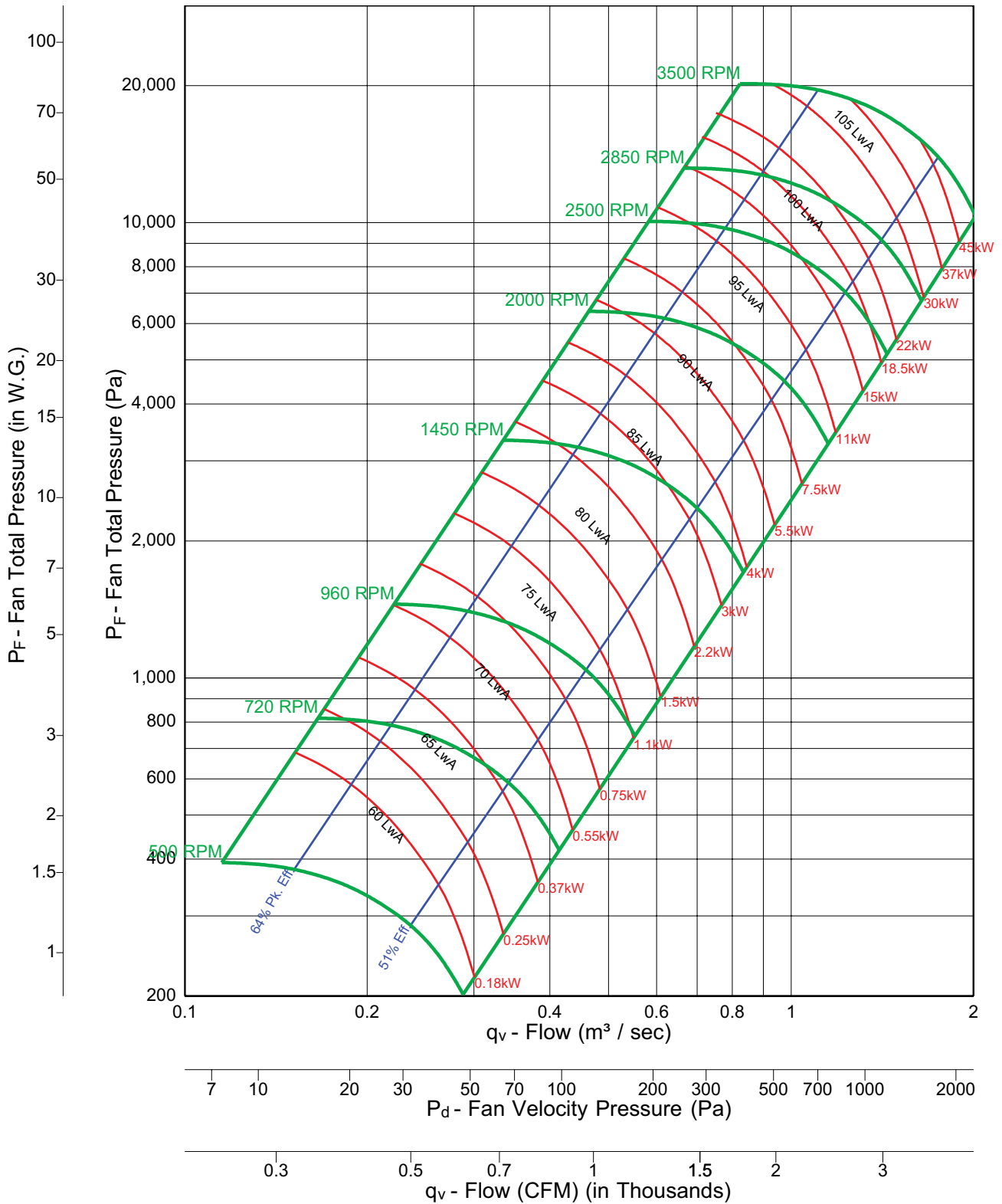

HRS 345

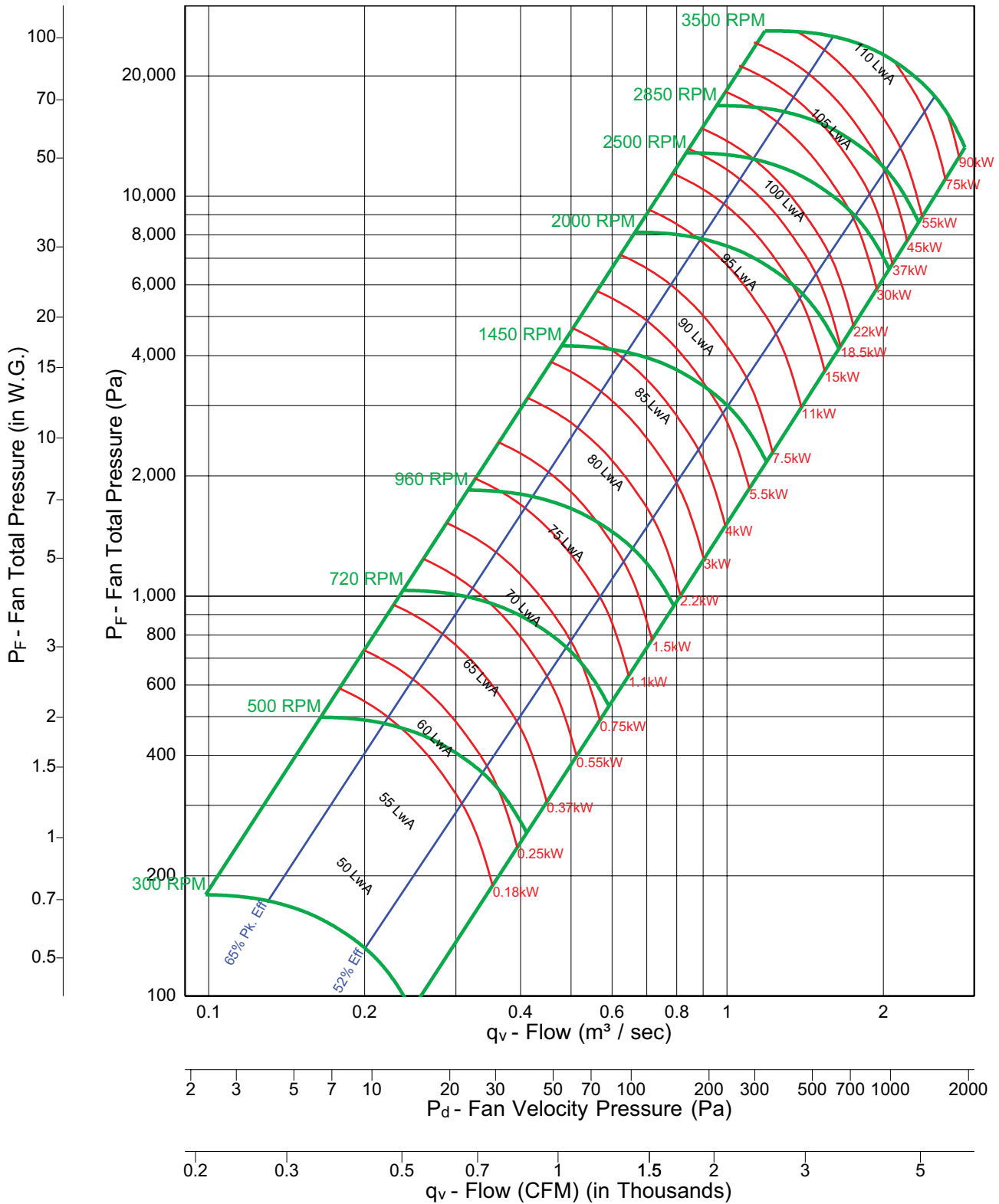

HRS 350

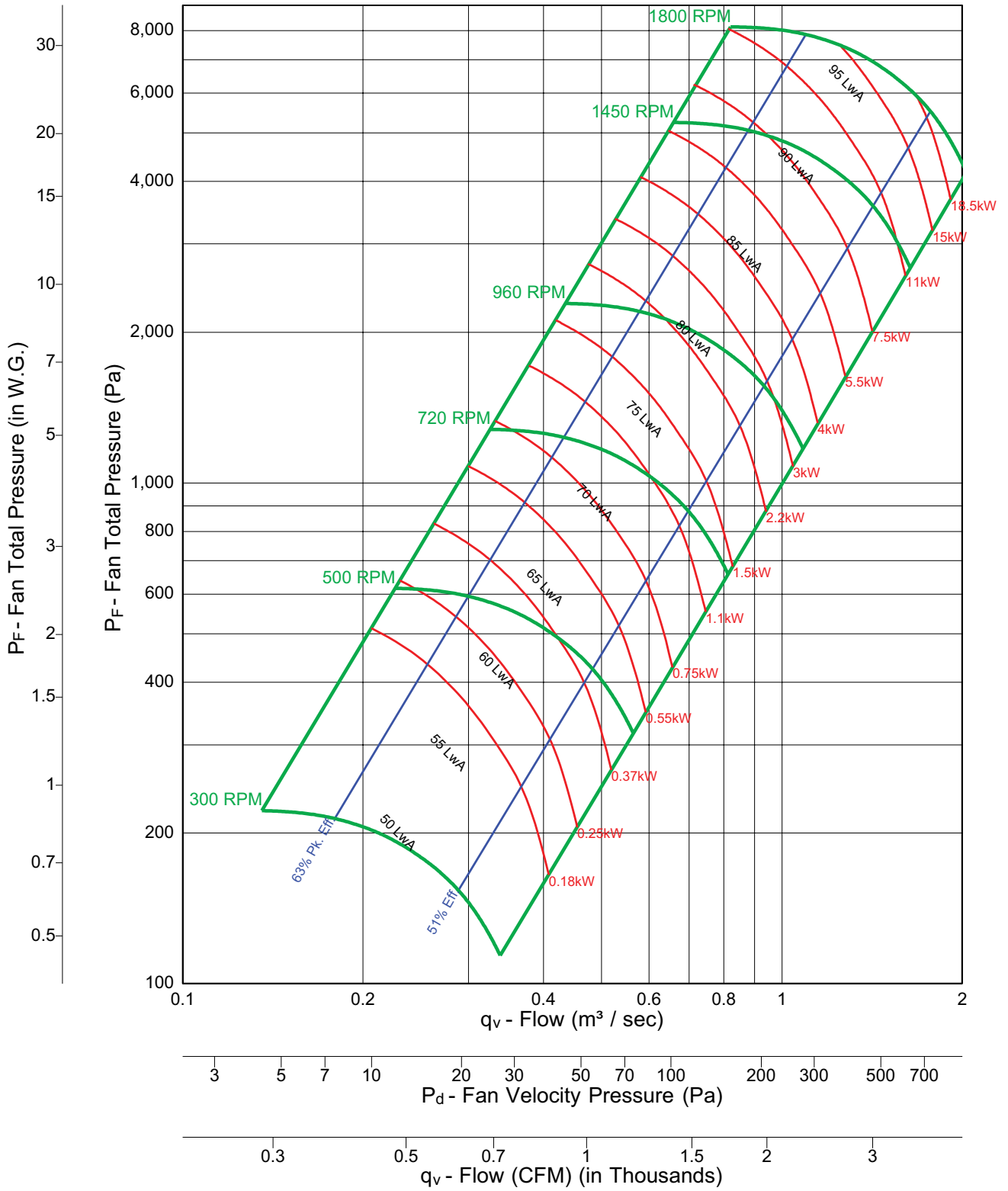

HRS 355 1800 RPM

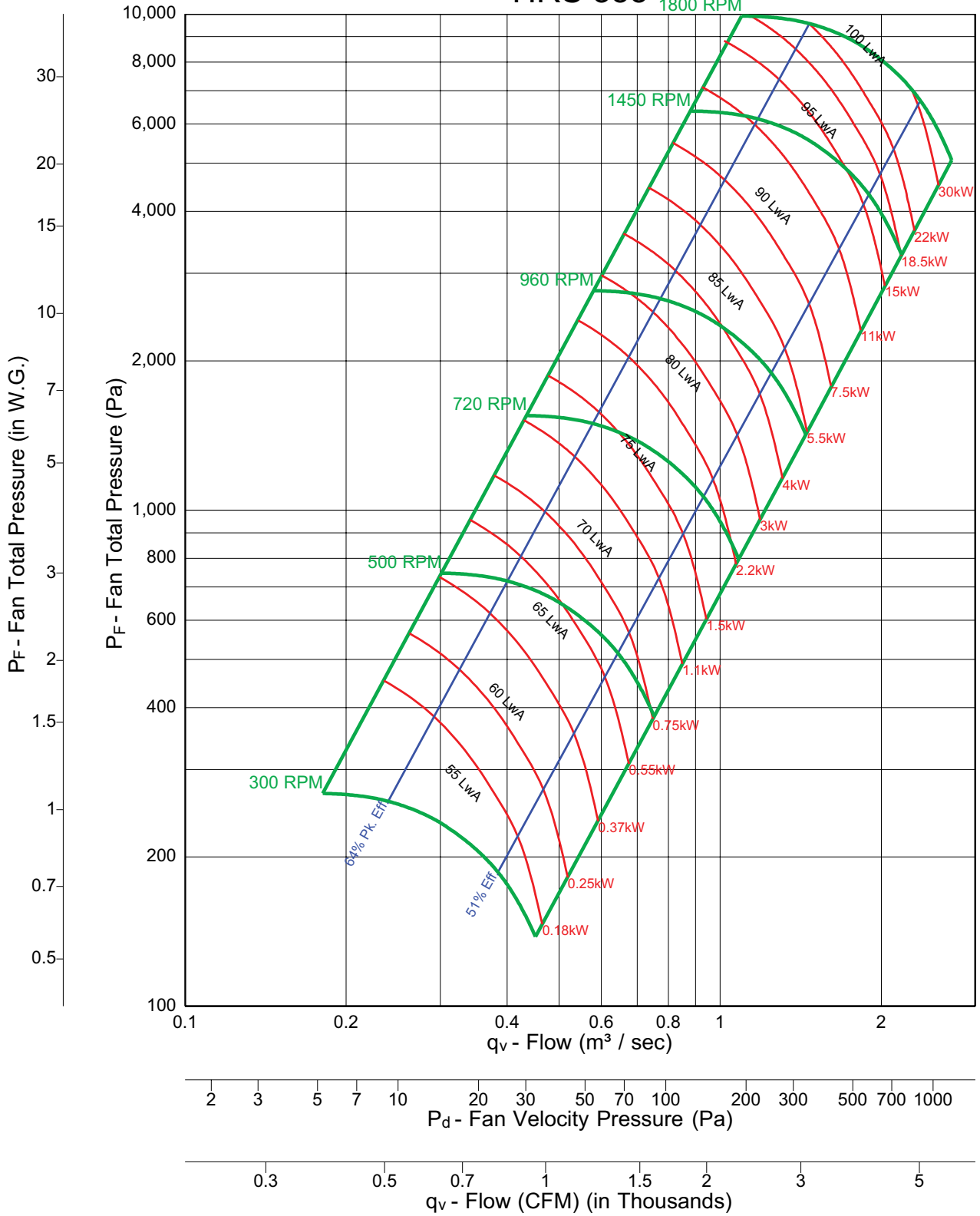

HRS 360

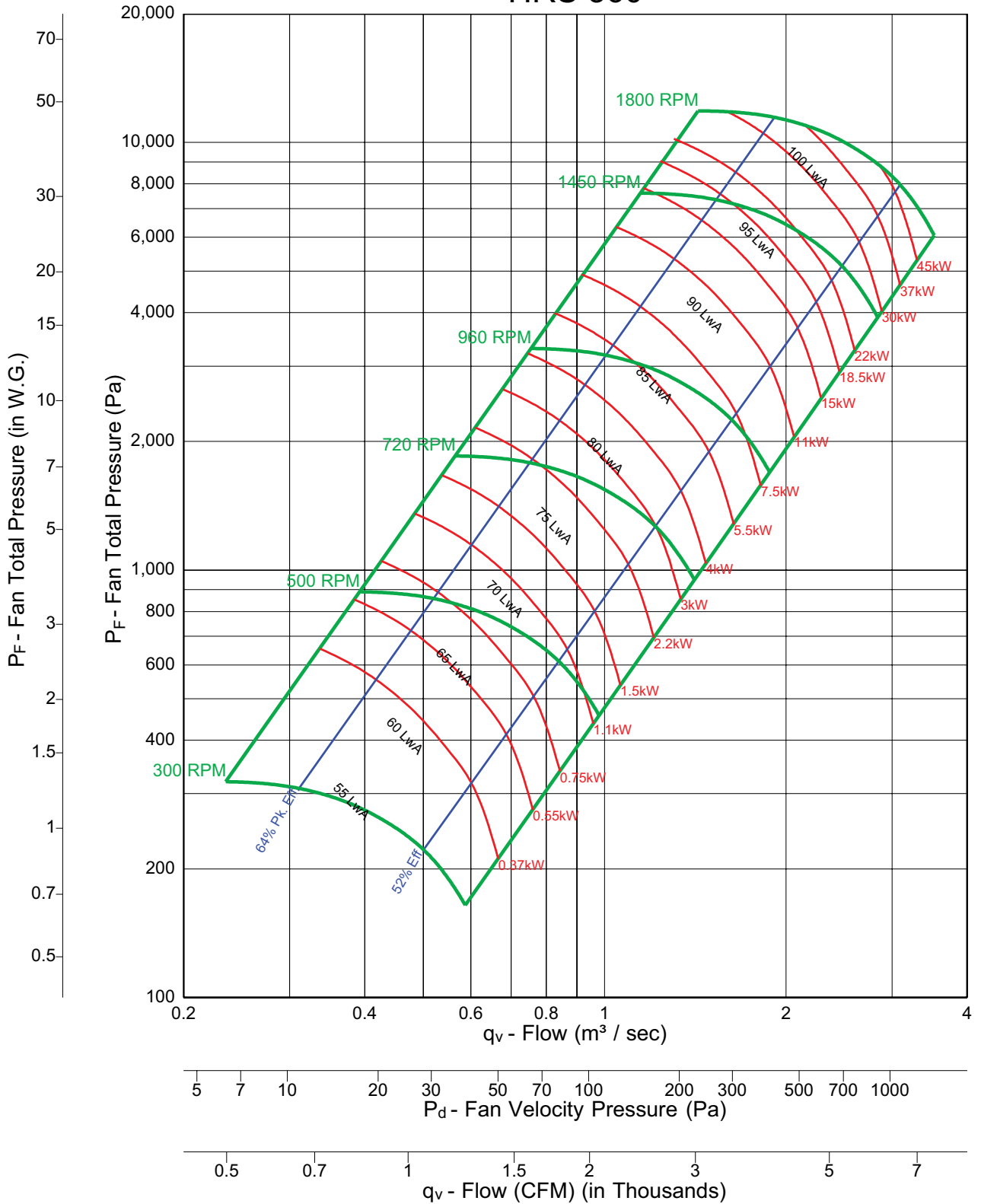

HRS 365

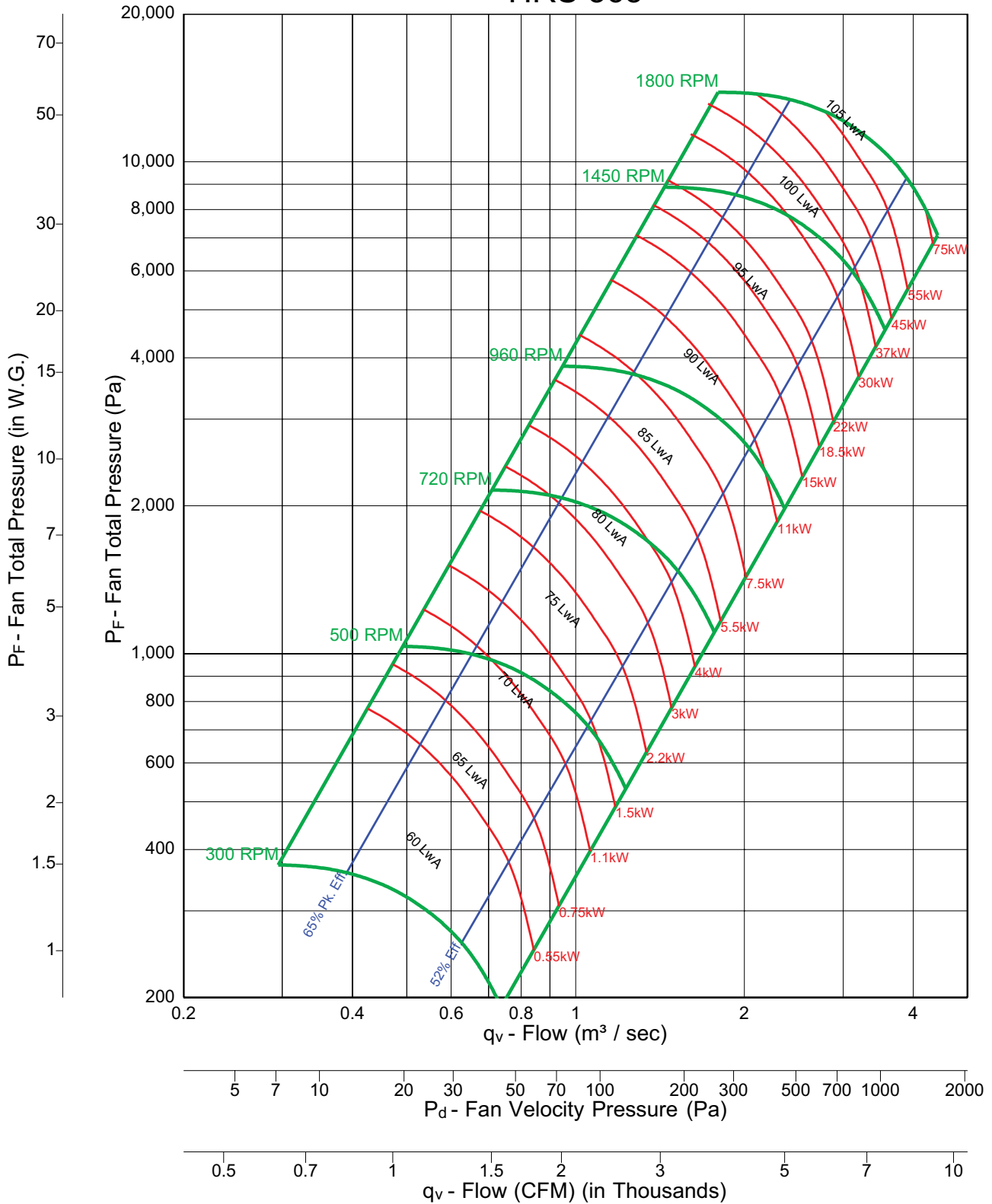

HRS 370

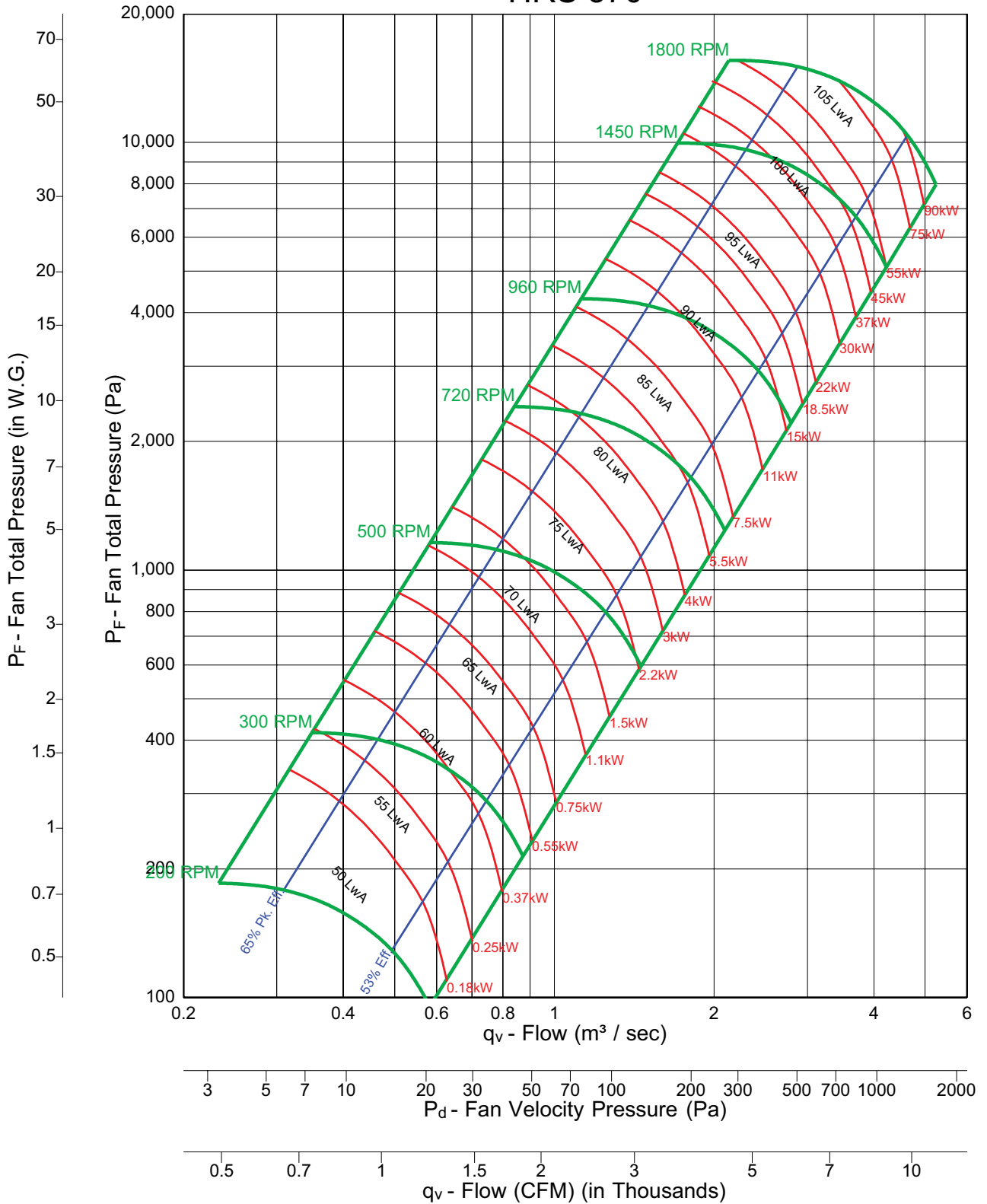

Arrangement 1, Design 1

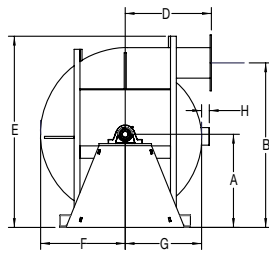

THD

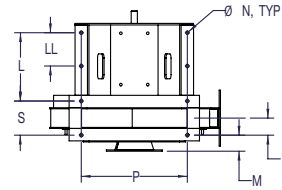
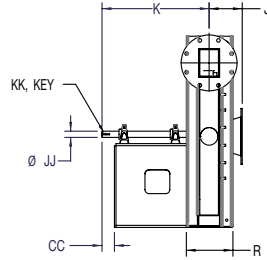

Foundation

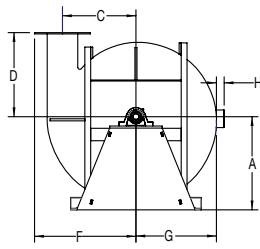

UBD

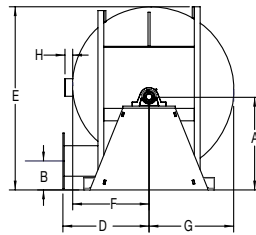

BHD

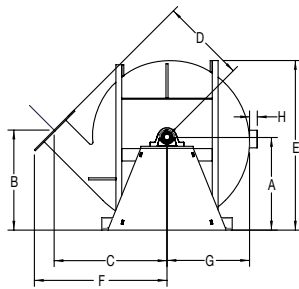

BAU

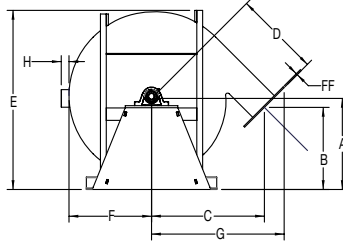

TAD

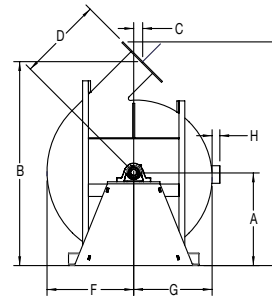

TAU

FAN SIZE	A				B								C				D	E					
	ALL DISCHARGES EXCEPT BHD				BHD	TAD	THD	TAU	BAU	BHD	UBD	TAD	THD	TAU	BAU	BHD		UBD	TAD	THD	TAU	BAU	BHD
125	357	402	324	656	813	391	103	704	456	346	34	456	103	299	346	688	751	880	672	702	668		
130	429	461	388	787	976	469	102	844	547	416	40	547	102	358	416	833	901	1043	810	847	804		
135	500	538	453	918	1138	547	120	985	638	485	47	638	120	418	485	983	1040	1219	958	1002	951		
140	572	613	518	1049	1301	625	135	1125	729	554	54	729	135	478	554	1100	1176	1391	1075	1122	1069		
145	643	675	582	1181	1464	704	137	1266	821	623	61	821	137	537	623	1264	1313	1553	1233	1272	1225		
150	715	746	647	1312	1626	782	149	1407	912	693	67	912	149	597	692	1394	1451	1725	1360	1403	1350		
155	786	837	712	1443	1789	860	180	1548	1003	762	74	1003	180	657	762	1529	1612	1888	1490	1550	1479		
160	857	85	776	1574	1951	938	179	1688	1094	831	81	1094	179	717	831	1650	1749	2073	1612	1684	1603		
165	929	955	841	1705	2114	1016	181	1829	1185	900	88	1185	181	777	900	1788	1885	2235	1747	1824	1737		
170	1000	1048	906	1836	2277	1094	212	1970	1277	970	94	1277	212	836	970	1936	2047	2398	1886	1964	1872		

FAN SIZE	F						G						H	J	K	L	LL	M	N	P	R	S	T
	TAD	THD	TAU	BAU	BHD	UBD	TAD	THD	TAU	BAU	BHD	UBD											
125	323	326	330	523	311	384	523	346	315	323	326	319	48	118	530	279	-	57	18	496	172	122	65
130	391	392	396	614	373	454	614	416	378	387	392	382	40	132	597	284	-	53	21	536	235	159	80
135	452	457	463	719	435	532	719	485	440	452	457	446	43	156	617	313	-	69	21	530	250	174	87
140	516	522	529	819	497	605	819	554	503	516	522	510	46	176	678	344	-	83	21	691	264	187	94
145	581	588	595	911	559	664	911	623	566	581	588	574	46	198	753	424	-	98	21	550	277	200	100
150	645	653	661	1011	622	737	1011	692	629	645	653	637	54	220	735	413	-	113	21	609	291	215	108
155	710	718	727	1102	684	797	1102	762	692	710	718	701	54	242	792	429	-	116	27	780	355	469	127
160	774	783	793	1215	746	888	1215	831	755	774	783	765	60	263	838	448	-	130	27	1042	368	267	133
165	839	849	859	1307	808	949	1307	900	818	839	845	829	60	285	888	473	236	145	27	923	382	280	140
170	903	914	925	1398	870	1008	1398	970	881	903	914	892	60	306	948	478	239	147	27	983	445	317	158

DIMENSIONS ARE SUBJECT TO CHANGE. CERTIFIED DRAWINGS AVAILABLE ON REQUEST.

Arrangement 1, Design 2

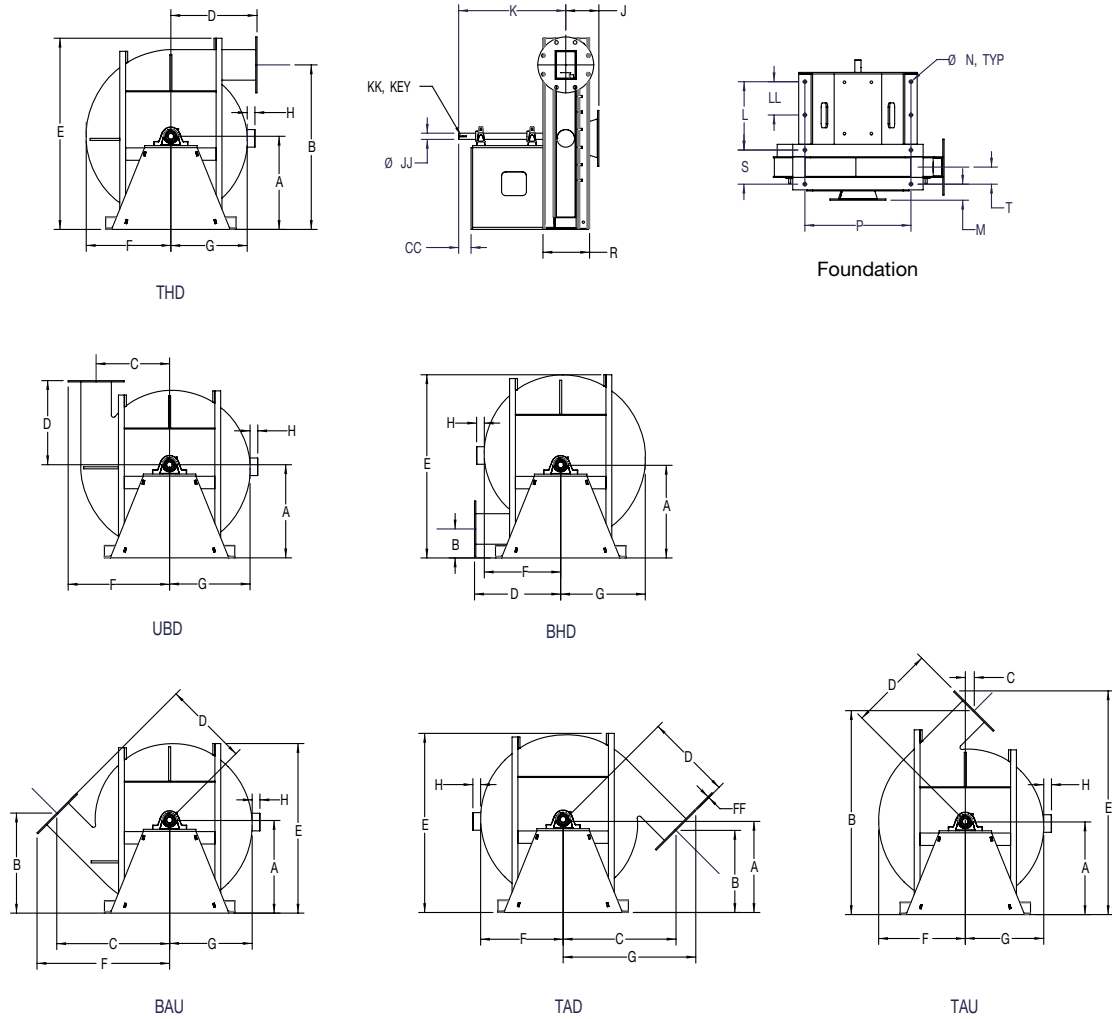

FAN SIZE	A		B						C						D	E					
	ALL DISCHARGES EXCEPT BHD	BHD	TAD	THD	TAU	BAU	BHD	UBD	TAD	THD	TAU	BAU	BHD	UBD		TAD	THD	TAU	BAU	BHD	UBD
225	354	408	319	643	797	388	119	692	444	338	35	444	119	289	338	685	751	873	661	706	655
230	424	481	382	771	956	466	134	830	532	406	42	532	134	347	406	837	900	1046	803	868	794
235	494	538	446	899	1116	543	133	968	621	474	49	621	133	405	474	985	1037	1205	948	1001	938
240	565	610	510	1028	1275	621	147	1106	710	541	56	710	147	463	541	1095	1175	1374	1057	1111	1048
245	635	699	573	1156	1435	699	178	1245	799	609	63	799	178	521	609	1263	1327	1556	1217	1291	1205
250	706	757	637	1285	1594	776	179	1383	888	677	70	887	179	579	677	1393	1456	1715	1342	1405	1328
255	778	848	701	1414	1753	854	211	1521	976	744	76	976	211	636	744	1532	1611	1875	1474	1558	1458
260	848	905	764	1542	1913	931	211	1660	1065	812	84	1065	211	694	812	1643	1746	2056	1586	1667	1572
265	918	962	828	1671	2072	1009	211	1798	1154	880	90	1154	210	752	880	1784	1882	2216	1718	1806	1703
270	989	1059	892	1799	2231	1086	249	1936	1243	947	98	1243	249	810	947	1939	2045	2402	1864	1951	1844

FAN SIZE	F						G						H	J	K	L	LL	M	N	P	R	S	T
	TAD	THD	TAU	BAU	BHD	UBD	TAD	THD	TAU	BAU	BHD	UBD											
225	320	325	331	520	302	397	520	338	308	320	325	314	48	122	534	279	-	57	18	481	180	130	65
230	384	391	398	622	362	474	622	406	369	384	391	376	40	129	609	284	-	45	21	520	245	169	84
235	448	456	464	711	423	532	711	474	431	448	456	439	43	140	643	313	-	48	21	512	262	185	93
240	511	521	530	809	483	602	809	541	492	511	521	502	46	148	719	344	-	48	21	671	276	200	100
245	575	586	597	920	543	692	920	609	553	575	586	564	46	160	807	424	-	52	21	534	292	216	108
250	639	651	663	1009	604	750	1009	677	615	639	651	627	54	177	794	413	-	61	21	53	307	231	116
255	703	716	729	1098	664	808	1098	744	677	703	716	690	54	194	859	429	-	58	27	755	373	271	136
260	767	781	796	1209	724	897	1209	812	738	767	781	753	60	210	899	448	-	68	27	1012	387	286	143
265	831	846	862	1297	785	955	1297	880	800	831	846	815	60	227	965	473	236	77	27	894	402	300	150
270	895	911	928	1413	845	1051	1413	947	861	895	911	878	60	244	1031	478	239	75	27	955	467	339	169

DIMENSIONS ARE SUBJECT TO CHANGE. CERTIFIED DRAWINGS AVAILABLE ON REQUEST.

Arrangement 1, Design 3

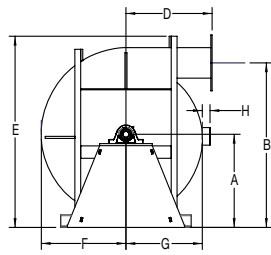

THD

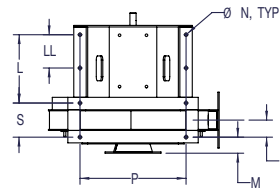
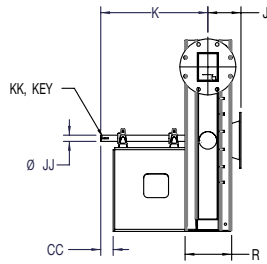

Foundation

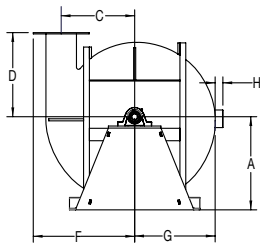

UBD

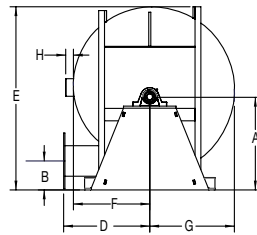

BHD

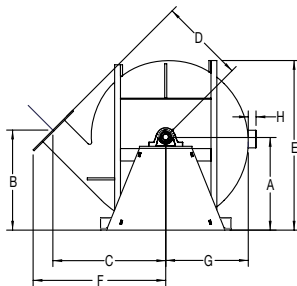

BAU

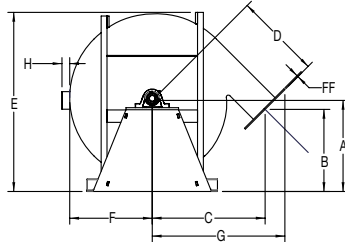

TAD

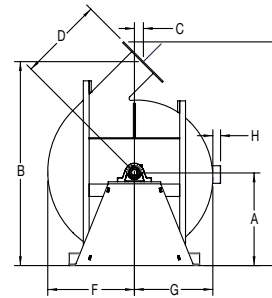

TAU

FAN SIZE	A		B						C				D	E							
	ALL DISCHARGES EXCEPT BHD	BHD	TAD	THD	TAU	BAU	BHD	UBD	TAD	THD	TAU	BAU		BHD	UBD	TAD	THD	TAU	BAU	BHD	UBD
325	349	416	315	631	782	384	134	680	433	330	35	433	134	282	330	683	758	872	650	721	642
330	419	473	378	757	939	461	135	816	519	396	41	519	645	338	396	846	899	1028	802	866	790
335	489	543	441	883	1095	537	148	951	606	463	48	606	148	394	463	957	1037	1194	910	982	899
340	559	629	504	1010	1251	614	178	1087	693	529	55	693	178	451	529	1099	1181	1373	1041	1124	1027
345	629	686	567	1136	1408	691	179	1223	779	595	62	779	178	507	595	1227	1309	1529	1170	1263	1156
350	699	775	630	1262	1564	768	211	1359	866	661	69	866	211	564	661	1396	1465	1708	1329	1420	1310
355	768	832	693	1388	1721	844	212	1495	953	727	76	953	812	620	727	1538	1608	186	1463	1543	1441
360	838	927	756	1515	1877	921	251	1631	1039	793	83	1039	251	676	793	1636	1756	2048	1560	1684	1541
365	908	984	819	1641	2034	998	251	1767	1126	859	90	1126	251	733	859	1794	1882	2204	1704	1824	1679
370	978	1067	882	1767	2190	1074	278	1903	1212	925	97	1212	277	789	925	1949	2042	2379	1852	1964	1825

FAN SIZE	F						G						H	J	K	L	LL	M	N	P	R	S	T
	TAD	THD	TAU	BAU	BHD	UBD	TAD	THD	TAU	BAU	BHD	UBD											
325	316	325	332	523	293	409	523	330	300	316	325	309	48	125	537	279	-	57	18	449	185	136	68
330	380	389	399	609	352	465	609	396	361	380	389	370	40	133	613	284	-	45	21	483	252	176	88
335	443	454	465	705	410	534	705	463	421	443	454	432	43	145	648	313	-	48	21	683	270	194	97
340	506	519	532	814	469	622	814	529	481	506	519	494	46	152	724	344	-	48	21	625	286	210	105
345	570	584	598	900	527	679	900	595	541	570	584	555	46	164	814	429	-	50	21	706	303	227	114
350	633	649	665	1010	586	767	1010	661	601	633	649	617	54	171	811	413	-	50	21	558	319	243	121
355	696	714	731	1096	644	823	1096	727	661	696	714	679	54	179	886	429	-	37	27	707	386	284	142
360	760	779	798	1210	703	918	1210	793	721	760	779	741	60	190	945	448	-	40	27	949	402	300	150
365	823	843	864	1296	761	974	1296	859	781	823	844	802	60	205	1003	473	236	47	27	834	418	316	158
370	886	909	931	1401	820	1056	1401	925	842	886	909	864	60	220	1072	478	239	42	27	890	484	356	178

DIMENSIONS ARE SUBJECT TO CHANGE. CERTIFIED DRAWINGS AVAILABLE ON REQUEST.

Arrangement 4, Design 1

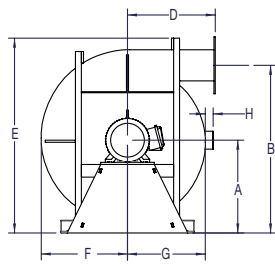

THD

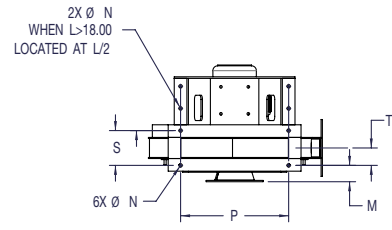
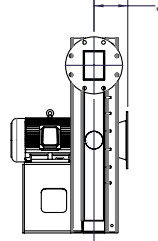

Foundation

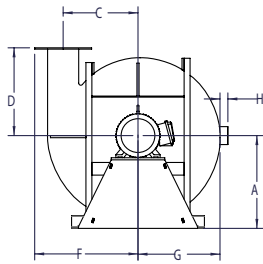

UBD

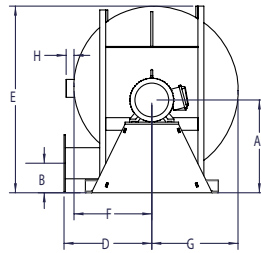

BHD

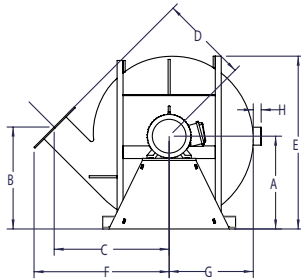

BAU

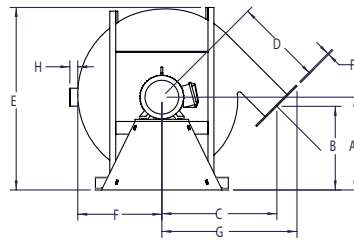

TAD

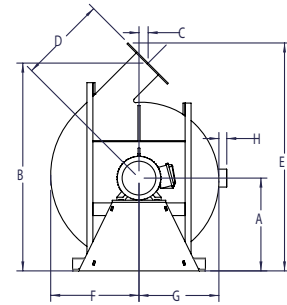

TAU

FAN SIZE	A		B						C						D	E					
	ALL DISCHARGES EXCEPT BHD	BHD	TAD	THD	TAU	BAU	BHD	UBD	TAD	THD	TAU	BAU	BHD	UBD		TAD	THD	TAU	BAU	BHD	UBD
125	357	402	324	656	813	391	103	704	456	346	34	456	103	299	346	688	751	880	672	702	668
130	429	461	388	787	976	469	102	844	547	416	40	547	102	358	416	833	901	1043	810	847	804
135	500	538	453	918	1138	547	120	985	638	485	47	638	120	418	485	983	1040	1219	958	1002	951
140	572	613	518	1049	1301	625	135	1125	729	554	54	729	135	478	554	1100	1176	1391	1075	1122	1069
145	643	675	582	1181	1464	704	137	1266	821	623	61	821	137	537	623	1264	1313	1553	1233	1272	1225
150	715	747	647	1312	1626	782	149	1407	912	693	67	912	149	597	692	1394	1451	1725	1360	1403	1350
155	786	837	712	1443	1860	860	180	1548	1003	72	7	1003	180	657	762	1529	1612	1888	1490	1550	1479
160	857	895	776	1574	1951	938	179	1688	1094	831	81	1094	179	717	831	1650	1749	2073	1612	1684	1603
165	929	957	841	1705	2114	1016	181	1829	1185	900	88	1185	181	776	900	1788	1885	2235	1747	1824	1737
170	1000	1048	906	1836	2277	1094	212	1970	1277	970	94	1277	212	836	970	1936	2047	2398	1886	1964	1872

FAN SIZE	F						G						H	J	M	N	P	R	S	T
	TAD	THD	TAU	BAU	BHD	UBD	TAD	THD	TAU	BAU	BHD	UBD								
125	323	326	330	523	311	394	523	346	315	323	326	319	48	118	57	18	496	172	122	61
130	387	392	396	614	373	454	614	415	378	387	392	382	40	132	53	21	536	235	159	80
135	452	457	463	719	435	532	719	485	440	452	457	446	43	156	69	21	530	250	174	87
140	516	522	529	819	497	605	819	554	503	516	522	510	46	176	83	21	691	264	187	94
145	581	588	595	911	559	664	911	623	566	581	588	574	46	198	98	21	550	277	200	100
150	645	653	661	1011	622	737	1011	692	629	645	653	637	54	220	113	21	609	291	215	108
155	710	718	727	1102	684	797	1102	762	692	710	718	701	54	242	116	27	780	355	254	127
160	774	783	793	1215	746	888	1215	831	755	774	783	765	60	263	130	27	1042	368	267	133
165	839	849	859	1307	808	948	1307	900	818	839	849	829	60	285	145	27	923	382	280	140
170	903	914	925	1398	870	1008	1400	970	881	903	914	892	60	306	147	27	983	445	317	158

DIMENSIONS ARE SUBJECT TO CHANGE. CERTIFIED DRAWINGS AVAILABLE ON REQUEST.

Arrangement 4, Design 2

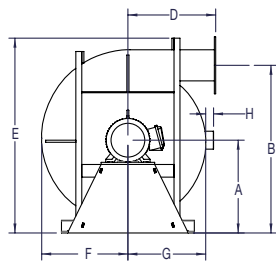

THD

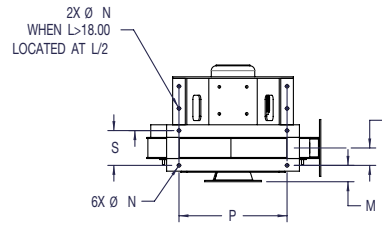
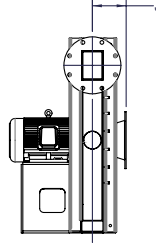

Foundation

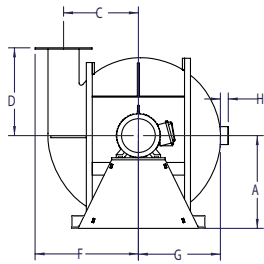

UBD

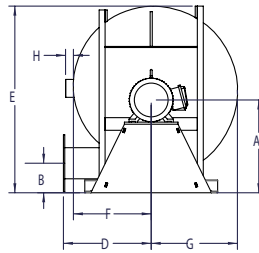

BHD

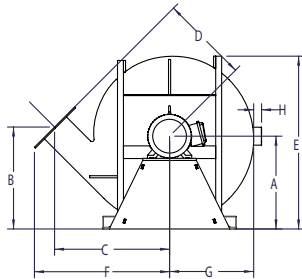

BAU

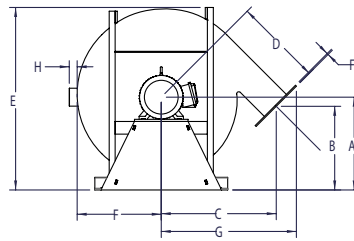

TAD

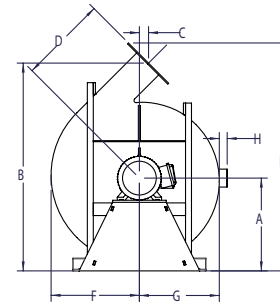

TAU

FAN SIZE	A		B						C				D	E							
	ALL DISCHARGES EXCEPT BHD	BHD	TAD	THD	TAU	BAU	BHD	UBD	TAD	THD	TAU	BAU		BHD	UBD	TAD	THD	TAU	BAU	BHD	UBD
225	354	408	319	643	797	388	119	692	444	338	35	444	119	289	338	685	751	873	661	706	655
230	424	481	382	771	956	466	134	830	532	406	42	532	134	347	406	837	900	1046	803	868	794
235	494	538	446	899	1116	543	133	968	621	541	49	621	133	405	474	985	1037	1205	948	1001	938
240	565	610	510	1028	1275	621	147	1106	710	541	56	710	147	463	541	1095	1175	1374	1057	1111	148
245	635	699	573	1156	1435	699	178	1245	799	609	63	799	178	521	609	1263	1327	1556	1217	1291	1205
250	706	757	637	1285	1594	776	179	1383	887	677	70	887	179	579	677	1393	1456	1715	1342	1405	1328
255	778	848	701	1414	1753	854	211	1521	976	744	76	976	211	636	744	1532	1611	1875	1474	1558	1458
260	848	905	764	1542	1913	931	211	1660	1065	812	84	1065	211	694	812	1643	1746	2056	1586	1667	1572
265	918	962	828	1671	2072	1009	210	1798	1154	880	90	1154	210	752	880	1784	1882	2216	1718	1806	1703
270	989	1059	892	1799	2231	1086	249	1936	1243	947	98	1243	249	810	947	1939	2045	2402	1864	1951	1844

FAN SIZE	F						G						H	J	M	N	P	R	S	T
	TAD	THD	TAU	BAU	BHD	UBD	TAD	THD	TAU	BAU	BHD	UBD								
225	320	325	331	520	302	397	520	338	308	320	325	314	48	122	57	18	462	180	130	65
230	384	391	398	622	362	474	622	406	369	384	391	376	40	129	45	21	520	245	169	84
235	448	456	464	711	423	532	711	474	431	448	456	439	43	140	48	21	512	262	185	93
240	511	521	530	809	483	602	809	541	492	511	521	502	46	148	48	21	671	276	200	100
245	575	586	597	920	543	692	920	609	553	575	586	564	46	160	52	21	534	292	216	108
250	639	651	663	1009	604	750	1009	677	615	639	651	627	54	177	61	21	593	307	231	116
255	703	716	729	1098	664	808	1098	744	677	703	716	690	54	194	58	27	755	373	271	136
260	767	781	796	1201	724	897	1209	812	738	767	781	753	60	210	68	27	1012	387	286	143
265	831	846	862	1297	785	955	1297	880	800	831	846	815	60	227	77	27	894	402	300	150
270	895	911	928	1413	845	1051	1413	947	861	895	911	878	60	244	75	27	955	467	339	169

DIMENSIONS ARE SUBJECT TO CHANGE. CERTIFIED DRAWINGS AVAILABLE ON REQUEST.

Arrangement 4, Design 3

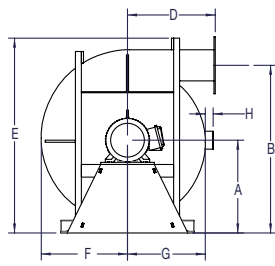

THD

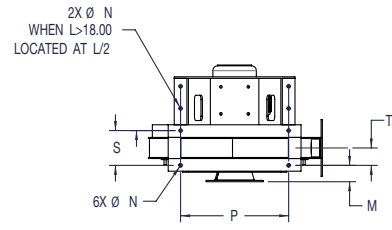
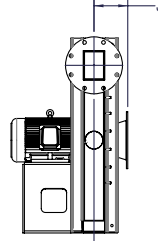

Foundation

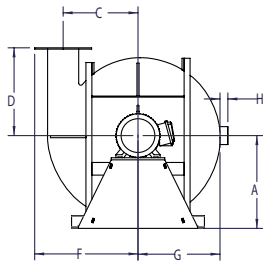

UBD

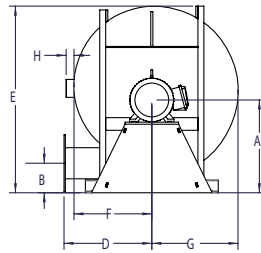

BHD

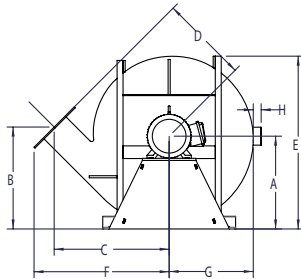

BAU

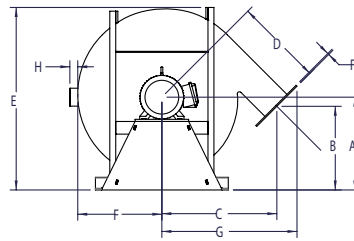

TAD

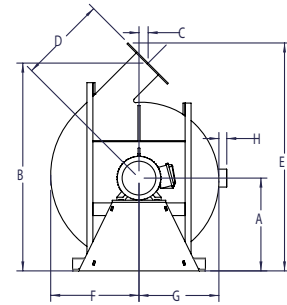

TAU

FAN SIZE	A		B						C						D	E					
	ALL DISCHARGES EXCEPT BHD	BHD	TAD	THD	TAU	BAU	BHD	UBD	TAD	THD	TAU	BAU	BHD	UBD		TAD	THD	TAU	BAU	BHD	UBD
325	349	416	315	622	782	384	134	680	433	330	35	433	134	282	330	683	758	872	650	721	642
330	419	473	378	927	461	135	816	519	396	41	519	135	338	396	846	899	1028	802	866	790	
335	489	543	441	883	1095	537	148	951	606	463	48	606	148	394	463	957	1037	1194	910	982	899
340	559	629	492	1010	1251	614	178	1087	693	529	55	693	178	451	529	1099	1181	1373	1041	1124	1027
345	629	686	567	1136	1408	691	179	1223	779	595	62	779	179	507	595	1227	1309	1529	1170	1263	1156
350	699	775	630	1262	1564	768	211	1359	866	661	69	866	211	564	661	1396	1465	1708	1329	1420	1310
355	768	832	693	1388	1721	844	212	1495	953	727	76	953	212	620	727	1538	1608	186	1463	1543	1441
360	838	927	756	1515	1877	921	251	1631	1039	793	83	1039	251	676	793	1636	1756	2048	1560	1684	1541
365	908	984	819	1641	2034	998	251	1767	1126	859	90	1126	251	733	859	1794	1882	2204	1704	1824	1679
370	978	1067	882	1767	2190	1074	278	1903	1212	925	97	1212	278	789	925	1949	2042	2379	1852	1964	1825

FAN SIZE	F						G						H	J	M	N	P	R	S	T
	TAD	THD	TAU	BAU	BHD	UBD	TAD	THD	TAU	BAU	BHD	UBD								
325	316	325	332	523	293	409	523	330	300	316	325	309	48	125	57	18	449	185	136	68
330	380	389	399	609	352	465	609	396	361	380	389	370	40	133	45	21	483	252	176	88
335	443	454	465	705	410	534	705	463	421	443	454	432	43	145	48	21	683	270	194	97
340	506	519	532	814	469	622	814	529	481	506	519	494	46	152	48	21	625	286	210	105
345	570	584	598	900	527	679	900	595	541	570	584	555	46	164	50	21	706	303	227	114
350	633	649	665	1010	586	767	1010	661	601	633	649	617	54	171	50	21	558	319	243	121
355	696	714	731	1096	644	823	1096	727	661	696	714	679	54	179	37	27	707	386	284	142
360	760	779	798	1210	703	918	1210	793	721	760	779	741	60	190	40	27	949	402	300	150
365	823	843	864	1296	761	974	1296	859	781	823	844	802	60	205	47	27	834	418	316	158
370	886	909	931	1401	820	1056	1401	925	842	886	909	864	60	220	42	27	890	484	356	178

DIMENSIONS ARE SUBJECT TO CHANGE. CERTIFIED DRAWINGS AVAILABLE ON REQUEST.

Arrangement 4, Pedestal Dimensions Design 1, Design 2 and Design 3

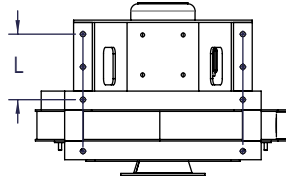
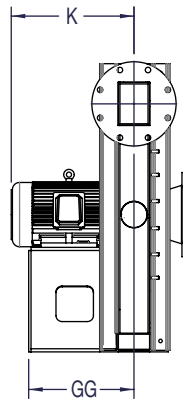

Foundation

FAN SIZE	FRAME SIZE	K
_25	90S	305
	90L	324
	112M	330
	132M	381
_30	90L	319
	112M	325
	132M	376
	160L	493
_35	180M	541
	112M	332
	132M	383
	160L	501
_40	180M	548
	180L	558
	200M	599
	200L	621
_45	132M	393
	160L	510
	180M	558
	180L	567
_50	200M	609
	200L	631
	225M	647
	250M	726
_55	160L	507
	180M	555
	180L	564
	200M	606
_60	200L	628
	225M	644
	250M	723
	280S	837
_65	315M	837
	160L	502
	180M	550
	180L	559
_70	200M	600
	200M	597
	200L	620
	225S	636
_75	225M	662
	250M	742
_80	250M	737
	280M	851
_85	280M	846
	315M	1068

FAN SIZE	FRAME SIZE	L	GG
_25	90L	254	309
	112M	298	354
	132M	343	398
	90L	249	304
_30	112M	293	349
	132M	338	393
	160L	439	495
	180M	452	507
_35	112M	300	356
	132M	345	401
	160L	447	502
	180L	491	547
_40	200L	535	591
	132M	355	410
	160L	456	512
	180L	501	556
_45	200L	545	600
	225M	574	629
	250M	631	686
	160L	453	509
_50	180L	498	553
	200L	542	598
	225M	570	626
	250M	628	683
_55	280M	720	775
	315M	926	982
	160L	448	504
	180L	493	548
_60	180L	493	548
	200M	499	554
	200L	534	589
	225S	540	596
_65	225M	589	645
	250M	646	702
_70	250M	641	697
	280M	734	789
_75	280M	729	784
	315M	935	991

DIMENSIONS ARE SUBJECT TO CHANGE. CERTIFIED DRAWINGS AVAILABLE ON REQUEST.

Inlet/Outlet Dimensions

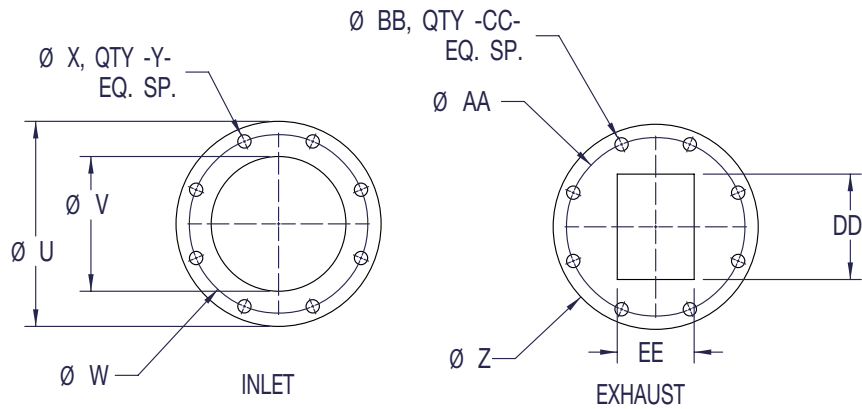

FAN SIZE	U	V	W	X	Y	Z	AA	BB	CC	DD	EE	FF OUTLET FLANGE THICKNESS
125	254	140	216	22	8	191	152	19	4	56	56	6
130	279	167	241	22	8	191	152	19	4	70	67	6
135	343	195	298	22	8	229	191	19	8	79	78	6
140	343	222	298	22	8	254	216	22	8	92	89	6
145	406	251	362	25	12	254	216	22	8	105	100	6
150	406	278	362	25	12	279	241	22	8	115	111	6
155	483	306	432	25	12	279	241	22	8	128	122	8
160	483	334	432	25	12	343	298	22	8	141	133	8
165	533	362	476	25	12	343	298	22	8	154	145	8
170	597	389	540	25	16	343	298	22	8	168	155	8

FAN SIZE	U	V	W	X	Y	Z	AA	BB	CC	DD	EE	FF FLANGE THICKNESS
225	254	138	216	22	8	216	178	19	8	64	80	8
230	279	165	241	22	8	254	216	22	8	79	97	8
235	343	193	298	22	8	254	216	22	8	90	113	8
240	343	220	298	22	8	279	241	22	8	105	129	8
245	406	248	362	25	12	343	298	22	8	116	145	8
250	406	275	362	25	12	343	298	22	8	131	161	8
255	483	303	432	25	12	343	298	22	8	146	177	8
260	483	330	432	25	12	406	362	25	12	160	193	8
265	533	358	476	29	12	406	362	25	12	175	209	8
270	597	385	540	29	16	483	432	25	12	190	225	8

FAN SIZE	U	V	W	X	Y	Z	AA	BB	CC	DD	EE	FF FLANGE THICKNESS
325	254	140	216	22	8	254	216	22	8	70	101	8
330	279	168	241	22	8	254	216	22	8	86	121	8
335	343	197	298	22	8	279	241	22	8	99	142	8
340	343	225	298	22	8	343	298	22	8	114	162	8
345	406	253	362	25	12	343	298	22	8	127	182	8
350	406	282	362	25	12	406	362	25	12	143	202	8
355	483	310	432	25	12	406	362	25	12	159	223	8
360	483	339	432	25	12	483	432	25	12	175	243	8
365	533	365	476	29	12	483	432	25	12	191	263	8
370	597	394	540	29	16	533	476	29	12	207	283	8

DIMENSIONS ARE SUBJECT TO CHANGE. CERTIFIED DRAWINGS AVAILABLE ON REQUEST.

ALTERNATIVE HIGH PRESSURE FANS

TBR

Radial bladed with backplate and shroud for low volume, high pressure applications.

Airflow to 3.78 m³/sec
Static pressures to 24,866 Pa

Additional information can be found in Catalogue M1200.

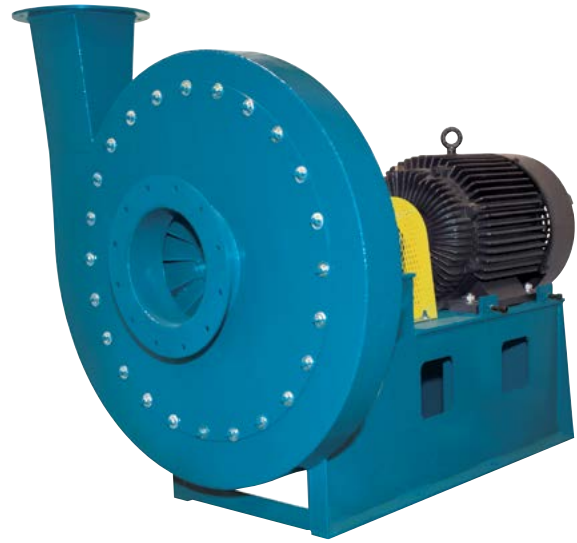

MBO / MBR / MBW

Three (3) impeller designs

Airflow to 8.97 m³/sec
Static pressures over 31,082 Pa

MBO - Open radial blades for handling hot, stick and abrasive airstreams.

MBR - Radial blades with front and back plate for handling clean, hot, or particulate laden airstreams. The most pressure and highest efficiency at a given speed of any MB-Series fan.

MBW - Radial blades with back plate and no front plate to handle long, stringy, or fibrous materials.

Additional information can be found in Catalogue M1400.

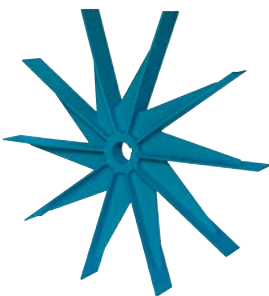

MBO Impeller



MBR Impeller

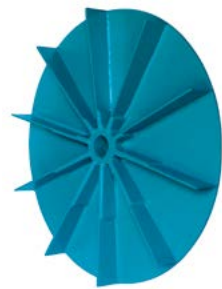

MBW Impeller

ALTERNATIVE HIGH PRESSURE FANS

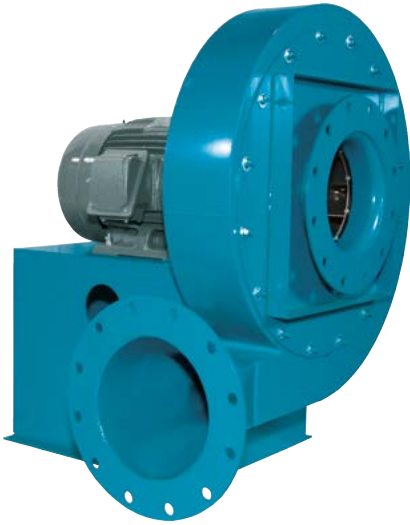

TBNA / TBNS

Turbo Pressure Blowers are used for applications requiring lower volumes and higher air pressures.

Airflow to 2.55 m³/sec

Static pressures up to 14,174 Pa

TBNS - Radial steel impeller designed to handle fumes, light particulates, and temperatures up to 315°C.

TBNA - Backward inclined aluminum impeller designed to handle clean-air applications up to 93°C.

Additional information can be found in Catalogue M1250.

TBA

Backward inclined blade for clean-air applications.

Airflow to 13.54 m³/sec

Static pressures to 17,406 Pa

Additional information can be found in Catalogue M1200.

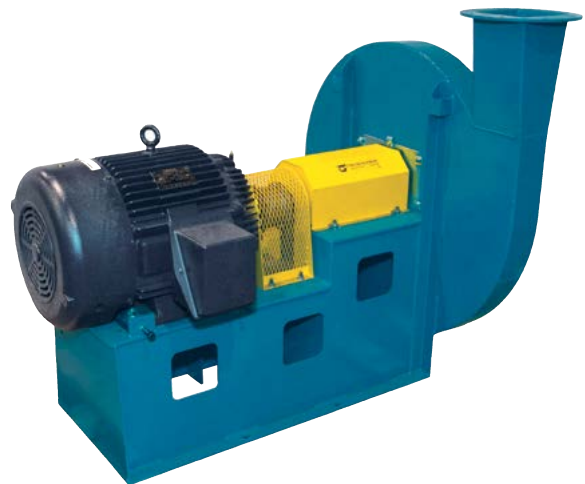

BCN

Lower volume, higher pressure fan utilizing a high efficiency, backward curved, non-overloading blade design. Suitable for clean to light particulate-laden air.

Airflow to 35.4 m³/sec

Static pressures to 24,866 Pa

Additional information can be found in Catalogue M1450.

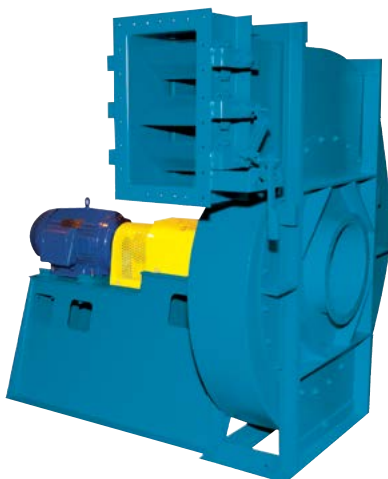



Model HRO

Furnish and install Model HRO High Pressure Radial Pressure Blower as manufactured by Twin City Fan & Blower, Minneapolis, Minnesota. Fans shall be specifically designed to handle specified volume and pressure to ensure rated performance.

PERFORMANCE — Fans shall be tested in accordance with ANSI/AMCA Standard 210 (air performance) and AMCA Standard 300 (sound performance) in an AMCA accredited laboratory.

HOUSING — Housings shall be made of a heavy gauge steel with continuously welded construction and braced with structural members to eliminate any resonant vibration and provide smooth operation. A shaft seal, drain with plug, flanged inlet and flanged outlet shall be provided as standard equipment. Inlet and outlet flanges shall be punched to ANSI 125/150# pattern.

IMPELLER — Impellers shall be of heavy gauge welded construction; riveted impellers are not acceptable. Blade orientation shall be radial in design to handle hot, sticky and abrasive airstreams as well as clean air applications. HRO impellers shall be open (no inlet shroud) to allow for particulate and vapor loading.

SHAFT (ARR 1 & 8 ONLY) — Shafts are to be solid material selected for AISI 1040 or 1045 hot rolled steel, accurately turned, ground, polished, and ring gauged for accuracy. Shaft design shall be of sufficient diameter to allow the first critical speed to be at least 1.43 times the maximum fan operating speed.

BEARINGS (ARR 1 & 8 ONLY) — Fans shall be supplied with heavy duty self-aligning grease lubricated anti-friction ball or roller bearings to provide long bearing life. Bearing support members shall be fabricated of heavy steel designed to insure maximum rigidity. Bearings shall be selected for a minimum average bearing life (AFBMA L-50) in excess of 200,000 hours at the maximum fan RPM.

FINISH AND COATING — The entire fan assembly, excluding the shaft, shall be thoroughly degreased and deburred before application of a rust-preventative primer. After the fan is completely assembled, a finish coat of paint shall be applied to the entire assembly. The fan shaft shall be coated with a petroleum-based rust protectant.

FACTORY RUN TEST — All fans prior to shipment shall be completely assembled. All fans up to 150 kW shall be test run as a unit at operating speed or maximum RPM allowed for the particular construction type. Each impeller shall be statically and dynamically balanced in accordance with ANSI/AMCA 204-96 "Balance Quality and Vibration Levels for Fans" to Fan Application Category BV-3, Balance Quality Grade G6.3. Balance readings shall be taken by electronic type equipment in the axial, vertical, and horizontal directions on each of the bearings. Records shall be maintained and a written copy shall be available upon request.

GUARANTEE — Manufacturer shall guarantee the workmanship and materials for its HRO fans for at least one year from startup, or eighteen months from shipment, whichever occurs first.



Model HRS

Furnish and install Model HRS High Pressure Radial Pressure Blower as manufactured by Twin City Fan & Blower, Minneapolis, Minnesota. Fans shall be specifically designed to handle specified volume and pressure to ensure rated performance.

PERFORMANCE — Fans shall be tested in accordance with ANSI/AMCA Standard 210 (air performance) and AMCA Standard 300 (sound performance) in an AMCA accredited laboratory.

HOUSING — Housings shall be made of a heavy gauge steel with continuously welded construction and braced with structural members to eliminate any resonant vibration and provide smooth operation. A shaft seal, drain with plug, flanged inlet and flanged outlet shall be provided as standard equipment. Inlet and outlet flanges shall be punched to ANSI 125/150# pattern.

IMPELLER — Impellers shall be of heavy gauge welded construction; riveted impellers are not acceptable. Blade orientation shall be radial in design to handle hot, sticky and abrasive airstreams as well as clean air applications. Impeller inlet side shall be shrouded providing more efficiency and allow light particulate and vapor loading.

SHAFT (ARR 1 & 8 ONLY) — Shafts are to be solid material selected for AISI 1040 or 1045 hot rolled steel, accurately turned, ground, polished, and ring gauged for accuracy. Shaft design shall be of sufficient diameter to allow the first critical speed to be at least 1.43 times the maximum fan operating speed.

BEARINGS (ARR 1 & 8 ONLY) — Fans shall be supplied with heavy duty self-aligning grease lubricated anti-friction ball or roller bearings to provide long bearing life. Bearing support members shall be fabricated of heavy steel designed to insure maximum rigidity. Bearings shall be selected for a minimum average bearing life (AFBMA L-50) in excess of 200,000 hours at the maximum fan RPM.

FINISH AND COATING — The entire fan assembly, excluding the shaft, shall be thoroughly degreased and deburred before application of a rust-preventative primer. After the fan is completely assembled, a finish coat of paint shall be applied to the entire assembly. The fan shaft shall be coated with a petroleum-based rust protectant.

FACTORY RUN TEST — All fans prior to shipment shall be completely assembled. All fans up to 150 kW shall be test run as a unit at operating speed or maximum RPM allowed for the particular construction type. Each impeller shall be statically and dynamically balanced in accordance with ANSI/AMCA 204-96 "Balance Quality and Vibration Levels for Fans" to Fan Application Category BV-3, Balance Quality Grade G6.3. Balance readings shall be taken by electronic type equipment in the axial, vertical, and horizontal directions on each of the bearings. Records shall be maintained and a written copy shall be available upon request.

GUARANTEE — Manufacturer shall guarantee the workmanship and materials for its HRS fans for at least one year from startup, or eighteen months from shipment, whichever occurs first.

INDUSTRIAL PROCESS AND COMMERCIAL VENTILATION SYSTEMS

CENTRIFUGAL FANS | UTILITY SETS | PLENUM & PLUG FANS | INLINE CENTRIFUGAL FANS
MIXED FLOW FANS | TUBEAXIAL & VANEAXIAL FANS | PROPELLER WALL FANS | PROPELLER ROOF VENTILATORS
CENTRIFUGAL ROOF & WALL EXHAUSTERS | CEILING VENTILATORS | GRAVITY VENTILATORS | DUCT BLOWERS
RADIAL BLADED FANS | RADIAL TIP FANS | HIGH EFFICIENCY INDUSTRIAL FANS | PRESSURE BLOWERS
LABORATORY EXHAUST FANS | FILTERED SUPPLY FANS | MANCOOLERS | FIBERGLASS FANS | CUSTOM FANS



TWIN CITY FAN & BLOWER
WWW.TCF.COM

5959 TRENTON LANE N | MINNEAPOLIS, MN 55442 | PHONE: 763-551-7600 | FAX: 763-551-7601

©2018 Twin City Fan Companies, Ltd., Minneapolis, MN. All rights reserved. Catalog illustrations cover the general appearance of Twin City Fan & Blower products at the time of publication and we reserve the right to make changes in design and construction at any time without notice.